

# EDUSIMSTEAM

## Learning Scenarios

Deliverable 3.1 EDUSIMSTEAM Learning Scenarios for Schools

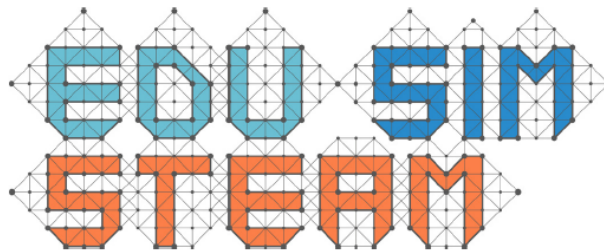

Erasmus+ KA3 Forward Looking Cooperation project



With the support of the  
Erasmus+ Programme  
of the European Union

This report is part of the Project "Fostering STEAM Education in Schools" that has received funding by the European Commission's Forward Looking Cooperation programme under grant agreement number 612855.

## Document Control Page

<b>Title</b>	EDUSIMSTEAM Learning Scenarios
<b>Version</b>	Report
<b>Deliverable number</b>	D.3.1
<b>Work package</b>	WP3
<b>Authors/ Organizations</b>	Erdoğan Çakıroğlu, METU Volkan Şahin, METU Yeliz Tunga, METU Ece Eren Şişman, METU Ayşe Nihan Şatgeldi, METU Elçin Erbasan, METU Anita Juškevičienė, Vilnius University Eduardo Peixoto, CTEM Academy Miguel Gonçalves, CTEM Academy
<b>Editors/ Organizations</b>	Erdoğan Çakıroğlu, METU
<b>Peer Reviewers</b>	Can Koyuncu, Robotsan Sümeyye Hatice Eral, MoNE Dr. İpek Saralar-Aras, MoNE Özge Taştan, MoNE Miguel Gonçalves, CTEM Academy
<b>Graphic Designer</b>	
<b>Date of delivery</b>	July 12, 2021
<b>Dissemination level</b>	Public

### Disclaimer

This project has been funded with support from the European Commission. This publication reflects the views only of the author, and the Commission cannot be held responsible for any use which may be made of the information contained therein.

## **Table of Content**

<b>Theme – Street Lighting in a Smart City</b>	<b>1</b>
Scenario 1: Detecting Inefficient Street Lighting	3
Scenario 2: Designing a Lighting Pole	6
Scenario 3: Placement of the Lighting Poles	10
Scenario 4: Designing Daylight Harvesting System	14
Scenario 5: Designing Motion-Detected Lighting System	18
Scenario 6: Light Like an Egyptian	21
<b>Theme – Waste Collection in a Smart City</b>	<b>24</b>
Scenario 7: Touch-Free Waste Container Design	25
Scenario 8: Detecting the Current Filling Level	28
Scenario 9: Monitoring Movement of Waste Bin	31
Scenario 10: Optimizing Smart Waste Monitoring System	34
<b>Theme – Mission to Mars</b>	<b>37</b>
Scenario 11: Designing a Mars Rover	38
Scenario 12: Collecting Rock Samples	42
Scenario 13: Ready for Mars	48
<b>Various Themes for Elementary Level</b>	<b>51</b>
Scenario 14: Ocean Sparkle	52
Scenario 15: Our Animal Friends	56
Scenario 16: Wonder Gardens	59
<b>Theme – Covid-19 Pandemic</b>	<b>62</b>
Scenario 17: Touch-Free Hand Sanitizer	65
Scenario 18: Detecting the Distance	68
Scenario 19: Monitoring the Air Condition	71
Scenario 20: Monitoring the Temperature and Humidity of the Room	75
<b>Theme - Mobility in a Smart City</b>	<b>78</b>
Scenario 21: Vehicle detection on a road	79
Scenario 22: Create a smart traffic light	82



## Theme – Street Lighting in a Smart City

Your city's municipality announced to the public that city counsellors had discussed digital transformation and smart city development at the municipal council. They have decided unanimously to move towards becoming a smart city. The Directorate of Research and Development Innovation (DRDI) under the Department of Strategy Development looks for ways to help the smart city design process and reshape the urban experiences. They examined several research reports about the city and conducted many public surveys to determine residents' current issues and needs. The surveys' results revealed that the residents' concerns are mostly related to street lighting, transportation system, waste management, traffic, and parking.

DRDI has explored sustainable and effective solution strategies for your city's digital transformation for a better environment and energy efficiency. The Smart City Master Plan (SCMP) was developed considering their reviews and the residents' needs.

The first step of the SCMP includes optimizing streetlamps, sensors, and street lighting to make your city's streets safer and friendly for the environment and dark skies. Currently, the DRDI collaborates with experts to enhance the SCMP to design the new city lighting process and develop a generalizable street lighting system by getting their opinions and experiences. The urbanization experts and municipality officials will be providing street lighting solutions considering guidelines published by international and national city planning organizations and regulations for decreasing light pollution. These guidelines identify the outdoor lighting policy by providing detailed reviews on technical standards, environmental and economic costs, and adaptable lighting solutions for future needs.

Although electric light provides many benefits, it can be a pollutant like plastics. As air, land, and water pollution, light pollution is a global environmental issue that causes many adverse effects on humans, wildlife behaviour, the environment, and the observation of celestial objects. According to the International Dark-Sky Association (IDA), light pollution, that is, the excessive or inappropriate use of artificial light, has four components:

**Glare** – excessive brightness that causes visual discomfort

**Sky glow** – brightening of the night sky over inhabited areas

**Light trespass** – light falling where it is not intended or needed

**Clutter** – bright, confusing, and excessive groupings of light sources

Like building lighting, commercial properties, advertisements, illuminated offices, and factories, streetlights can also be sources of light pollution due to their inefficiency, excessive brightness, improper shielding and protection, poor targeting, and sometimes, completely unnecessary. Therefore, such indecent use of light causes wasting too much electricity and energy with significant economic and environmental impacts. Consequently, IDA supports the lighting systems that are likely to minimize the harmful effects of light pollution by reducing sky glow, glare, and light trespass and encourage lighting to be:

- Only be on when needed
- Only light the area that needs it
- Be no brighter than necessary
- Minimize blue light emissions
- Be fully shielded (pointing light downward)

Good and accurate visibility on roadways and sidewalks produced by street lighting at night is a critical issue for both vehicular and pedestrian traffic. People are generally likely to think that the excessive light on streets, parks, or other areas is good, especially for security purposes, but in fact, it might be as bad as poor lighting. Thus, how much lighting is enough? The main focus is to link lighting with the night functions of a particular area of interest.

The efficient and high-quality street lighting depends on many factors and quality criteria of light, such as light sources, light colour and temperature, colour rendering, light distribution, or glare. For example, the quality of light can change based on the light sources (lamps) used in street lighting fixtures. High-pressure sodium (HPS) lamps as a light source, commonly used in city street lighting, emit a yellowish-orange colour light that produces poor colour rendition. On the other hand, metal halide and light-emitting diodes (LEDs) are two common light sources emitting a white glow that accurately render colour, provide better visual clarity, and consume less wattage for the same perceived visibility. LED can offer remarkably high luminance levels, so yellowish, neutral, and bluish-white light colours (colour temperatures between 2500 and 5000 Kelvin) are generally used for lighting the street during the night hours.

The quality of light is also affected by the relationship between the intensity of the light and distance from the light source (quantity of light). Therefore, placement, height, type, and wattage influence the brightness of a street. Since light gets dimmer while moving away from the source, the height of the luminaire must be adjusted for a given brightness and desired quality of light. The amount of wattage is also a significant factor that is responsible for adequate street lighting.

## Scenario 1: Detecting Inefficient Street Lighting

**Description:** Design a device that will determine the areas having inefficient lighting.

**Theme:** Street Lighting in a Smart City

**Grade Level:** Middle Schools / Junior High Schools (Ages 10 to 14)

**Duration:** 2 class hours

### Real-Life Scenario Setting

Considering factors affecting the design and use of a thriving street lighting system in the city, DRDI thinks that the first step of SCMP related to new lighting project should include the decisions of the areas that have inefficient (too much or little) lighting in the given street and determine the factors that can affect the amount of lighting on the streets. This process will help determine the problems in street lighting and develop sustainable and effective solutions for your city's digital transformation.

Suppose you will be a team member at the DRDI office and responsible for turning your city into a smart city with a new lighting project. Your team will have several tasks towards smart street lighting in the city by developing an adaptable lighting plan and implementing your lighting solution on the robotics simulation program.

### Task

In this activity, the task of each team is to:

- a. Observe the lighting on the streets given in the simulation environment.
- b. Determine the improper lighting spots by using light sensors.
- c. Report light levels by numerical values. You can compare the light levels on your streets with the acceptable light levels (given information in the technical part).
- d. Prepare a report and present it to the other teams of DRDI.

### Technical Information

Did you ever walk on a poorly lighted street, too dark or too bright? It is important to adjust light levels appropriately to walk safely on the street for people and minimize light pollution for the environment. There are many factors that specialists pay attention to when designing light poles, such as pole height, the shape of the lamp, etc. From a physics aspect, there are several terms that we need to know to understand lighting:

**Luminous flux:** refers to the rate of light emitted from a light source per unit of time. It is measured in *lumen (lm)* and represented by  $\phi$ .

**Luminous intensity:** Light sources emit light in different directions with different amounts. Luminous intensity refers to luminous flux but in a specific direction. It is measured in *candela (cd)* and represented by  $I$ .

**Illuminance:** It refers to the amount of light that reaches a surface. This term indicates if a surface is lighted appropriately to walk, ride, drive, etc. It is measured in *lux (lx)* and represented by  $E$ .

As you can see, to design or investigate a light pole, if it is appropriate or not in terms of light level, we need to consider illuminance. For medium-density streets, including pedestrians and cyclists, illuminance should be at least 7.5lx. This value can increase according to the density of street usage. For example, 50lx can be appropriate for roads with heavy traffic conditions.

### Prerequisite Skills

- Investigate the proper and appropriate outdoor lighting conditions
- Understand that light travels through straight paths in all directions

### STEAM Learning Outcomes

#### Science

- Use luminous flux, luminance, and illuminance in explaining lighting.
- Determine light pollution.

#### Technology

- Use a light sensor
- Use led or buzzer module
- Use branching module
- Create flowcharts in the simulation environment
- Run an algorithm

#### Engineering

- Make designs for street lighting poles and fixtures

#### Arts

- Gain awareness on light pollution
- Gain awareness on energy consumption
- Gain environmental awareness

#### Mathematics

- Use ratios and proportions

### Activity Process

Teachers are recommended to follow the following steps:

- Encourage students to carefully read the task statement and brainstorm about lighting conditions around their neighbourhood. Ask students:
- Have you ever thought about lighting conditions on the streets? Do you come across streets that have poor or excessive lighting conditions?
- Do these poor or excessive lighting conditions cause problems? What kind of problems can they create for both pedestrians and drivers?
- What are the factors that may affect light levels?
- Guide students to set up a sensor that can be used to measure light levels in various places on the map.
- Ask students to use and determine inefficient lighting areas on the map.
- Ask students to determine the factors that affect light level when they move the sensor around a light pole.



## Assessment

The following question can be considered for formative assessment purposes.

- What are the definitions of luminous flux, luminance, and illuminance?
- What are the units of these terms?
- What are the definitions of these units?
- What is the term used for light level?

The following are expected from students:

- Develop a sensor that can measure the illuminance of several points on the map in the simulation environment.
- Write and share a report on the lighting issues on the map using technical terminology appropriately.

## Career Connections

City and Regional Planning, Electric and Electronic Engineering, Earth and Space Science, Environmental Engineering

## Materials

The Simulation environment including a street map and light sensors

## Related Resources

Project for Public Spaces. (2008). Lighting Use & Design.  
<https://www.pps.org/article/streetlights>.

Römhild, T. (2017). (rep.). *Dynamic Light Handbook about Interpretation of En 13201*. European Union. Retrieved from  
<https://www.interreg-central.eu/Content.Node/Dynamic-Light/04-DL-Handbook-about-interpretation-of-EN-13201.pdf>

## References

Schreuder, D. (2008). *Outdoor lighting: Physics, vision, and perception*. Springer.

## Scenario 2: Designing a Lighting Pole

**Description:** Design a lighting pole by considering its height, the type of the bulb, luminous efficacy of the bulb, and tilt angle of lighting head for appropriate street lighting.

**Theme:** Street Lighting in a Smart City

**Grade Level:** Middle Schools / Junior High Schools (Ages 10 to 14)

**Duration:** 2 class hours

### Real-Life Scenario Setting

Since DRDI decided to transform the street lighting system into a smart design, the existing lighting poles were found to be old-fashioned. Therefore, all of them will be replaced with a new lighting pole design. While deciding the new lighting poles for an efficient and well-qualified smart lighting system, several criteria are to be considered, such as its height, the type of the lamp, the lamp's luminance wattage, and the tilt angle of the lamp the lighting head.

One of the essential components of the lighting poles is their heights. The height of the pole is called "mounting height" in lighting terminology, and mounting height can be defined as "the vertical distance between the road surface and the centre of the apparent light source of the luminaire." In other words, mounting height is the pole elevation relative to the road surface. The intensity of illumination, uniformity of brightness, area covered, and relative glare of the lamp are affected by the height of the lighting pole. Higher-mounted lamps can help to distribute the glare better. Namely, they can provide more uniformity (homogenously distributed light onto the ground), greater coverage (lighted more areas on the ground up), and reduction of glare (decrease in the amount of the light reflected from the ground). On the other hand, increasing the height of the street lighting poles may cause a lower illumination level. Since a lamp's illumination level is inversely proportional to the square of the distance from the lamp, doubling the distance causes a decrease in the illumination level to one-fourth of its original value. In addition, the height of the lighting pole is chosen bigger than the road width. The height of the lighting pole can be taken as 10-12 meters for streets with high traffic density and 6-8 meters for streets with low traffic density.

The other crucial components in the design process of the street lighting poles are the type of bulbs used and the luminous efficacy of the bulbs. The traditional incandescent bulbs are not used much in street lighting due to their low luminous flux and short lifetime. Generally, the three types of high-intensity discharge (HID) bulbs used in most street/road lighting designs and installations in recent decades. These bulbs are high-pressure sodium (HPS), metal halide (MH), and mercury vapour (MV) lamps. Also, light-emitting diodes (LED) have recently become more common in street lighting since they are more affordable and more energy-efficient.

Another component that should be considered in the design process of the street lighting poles is the tilt angle of the lighting head. The tilt angle can be defined as the angle between the arm of the lighting pole and the ground. When the lighting head is tilted more, more light is distributed in more areas on the road. When the lighting head is tilted less, the light covers the area in front of the lighting pole. Because of the tilt angle, pedestrians and drivers may be exposed to intense light and irritating glare.

## Task

While designing a lighting pole, the task of each team is to:

- Decide an appropriate height for the lighting poles.
- Decide an appropriate bulb type based on its luminous efficacy.
- Decide an appropriate tilt angle of the lighting head for proper lighting.
- Make your decisions based on your measurements from the light sensors. Observe and measure different choices and record them before making a decision. Determine your lighting pole design by optimizing all components of it.
- Write and share a report defending your decisions.

## Technical Information

**Luminous efficacy:** The efficiency of a light source depends on how much power the source needs and how much light it produces. If you look at light bulb boxes, you see that there is Watt and lumen information on them.

For example, while a LED bulb with 7W has 850 lm, another LED bulb with the same power has 1200lm luminous flux. Approximately, the first one has 121 lm/W, and the second one has 92lm/W. It means that the first LED bulb gives more light with the same amount of power. Table 2 shows examples of the efficiency of different light bulbs.

Table 1. Light bulb comparisons

	Power (W)	Luminous flux (lm)	Luminous efficacy (lm/W)
LED	27	2500	92.6
Fluorescent	36	2500	69.4
Incandescent	40	415	10.4

Illuminance depends on three factors: the intensity of light source ( $I$ ), the distance between the light and the surface ( $d$ ), and the angle of the surface ( $\theta$ ). Mathematically, we can show their relationship with the formula:

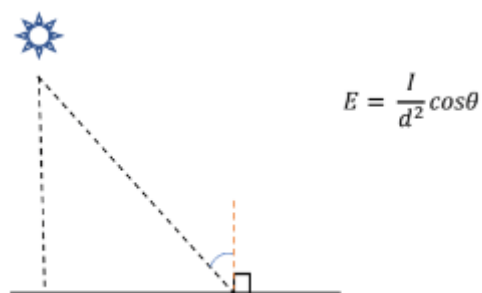

## Prerequisite Skills

- Explain the illuminance
- Explain the factors that affect illuminance

## STEAM Learning Outcomes

### Science

- Determine illuminance to minimize light pollution due to the design of the streetlights.
- Determine illuminance by taking the intensity of the light source, the distance between the light and the surface, and the angle of the surface into consideration.

### Technology

- Use a light sensor
- Use already created lighting pole components
- Use simulation environment.
- Record and analyse data through a spreadsheet application

### Engineering

- Use design processes and decision-making based on measurements from light sensors.

### Arts

- Make decisions about lighting pole component choices
- Gain awareness on the design process of the lighting poles

### Mathematics:

- Solve problems related to ratios and proportions

## Activity Process

Teachers are recommended to follow the following steps:

- Encourage students to carefully read the task statement and brainstorm about the design of lighting poles around their neighbourhood. Ask students following questions:
  - Have you ever thought about the design of lighting poles?
  - How industrial designers and engineers can design the poles?
  - What can be the factors that affect the designs of the lighting poles?
  - Do they locate lighting poles similarly on all streets?
- Guide students to make trials about the components of the lighting poles, namely, height, the type of the lamp, luminous efficacy of the bulb, and tilt angle of lighting head on the simulation environment.
- Guide students to observe their trials and the current situations of the components/variables relative to each other. Ask students to record and tabulate data.
- Ask students to develop ideas about optimizing the variables and the most appropriate design of their lighting poles.
- Encourage students to share their strategies and write a report for defending their strategies and conclusions regarding the design of the lighting poles.

## Assessment

The following question can be considered for formative assessment purposes.

- What are the components of lighting poles that affect their design?

- What are the factors that affect the illuminance?

The following are expected from students:

- Optimize the components of the lighting pole by considering energy consumption, efficiency, and costs.
- Decide on a reasonable and defensible street lighting pole design.

### **Career Connections**

Industrial Design, City and Regional Planning, Electric and Electronic Engineering, Environmental Engineering

### **Materials**

Street lighting pole components in the simulation environment

### **Related Resources and References**

Austrian Energy Agency. (2017). (rep.). *LED Street Lighting: Procurement & Design Guidelines*. Retrieved from <https://ec.europa.eu/research/participants/documents/downloadPublic?documentIds=080166e5b6d1cf07&appId=PPGMS>

Energex and Ergon Energy. (n.d.). *Public Lighting Design Manual*. Retrieved from [https://www.ergon.com.au/\\_data/assets/pdf\\_file/0005/216950/Public-lighting-design-manual.pdf](https://www.ergon.com.au/_data/assets/pdf_file/0005/216950/Public-lighting-design-manual.pdf)

International Institute for Energy Conservation (IIEC). (2015). (tech.). *Energy Efficiency Guidelines for Street Lighting in the Pacific*. Retrieved from [http://prdrse4all.spc.int/system/files/energy\\_efficiency\\_guidelines\\_for\\_street\\_lighting\\_in\\_the\\_pacific.pdf](http://prdrse4all.spc.int/system/files/energy_efficiency_guidelines_for_street_lighting_in_the_pacific.pdf)

The University of Iowa. (n.d.). *Statewide Urban Design and Specifications (SUDAS)*. Statewide Urban Design and Specifications (SUDAS) | RIO Iowa Project. <https://rio.urban.uiowa.edu/smart-planning-toolbox/statewide-urban-design-and-specifications-sudas>.

### Scenario 3: Placement of the Lighting Poles

**Description:** Place the lighting poles according to spacing for appropriate lighting.

**Theme:** Street Lighting in a Smart City

**Grade Level:** Middle Schools / Junior High Schools (Ages 10 to 14)

**Duration:** 2 class hours

#### Real-Life Scenario Setting

While placing the new lighting poles for an efficient and well-designed lighting system, DRDI decided to consider several criteria. Some of them are the distance between successive lighting poles, the base of the lighting pole, the type of the bulb used and its luminous efficacy, the pedestrian capacity, average traffic density, the structure of the street, buildings around the street, and safety considerations.

The distance between successive lighting poles, i.e., the relative positioning of two lighting poles, is called “the spacing” in lighting terminology. It is measured along the centreline of the roadway. Positioning the lighting poles makes sure that the surrounding has enough lighting. However, more illuminance levels on the street may affect the visibility negatively because of more glare and may cause light pollution because of over lighting in intersection areas. On the other hand, positioning the lighting poles away from each other results in less lighting in some areas for pedestrians and drivers.

There are alternative lighting pole arrangements: (i) single-sided placement, (ii) opposite placement, (iii) staggered placement, and (iv) twin central placement (Figure 1).

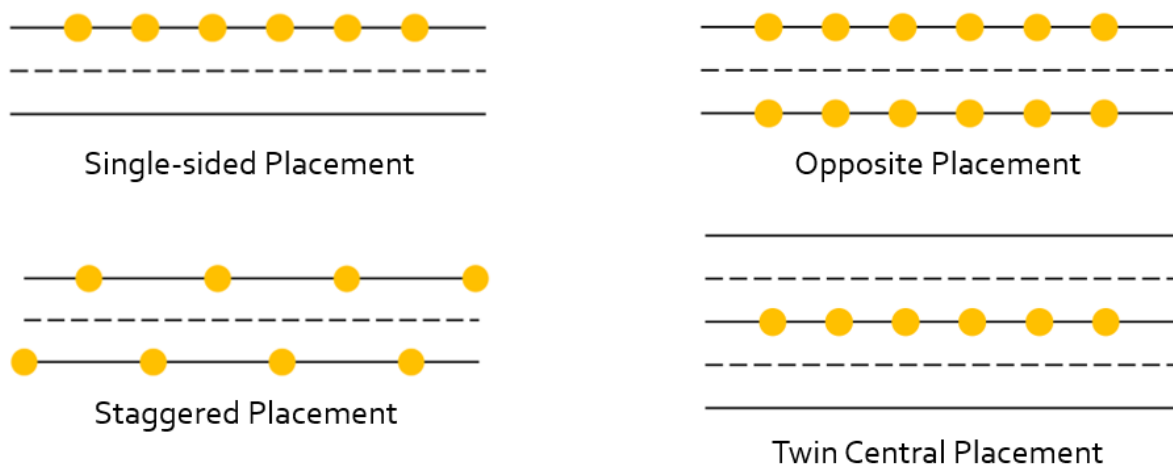

Figure 1. Lighting Pole Placement Types

Generally, single-sided placement is used in streets with low traffic density and a width of fewer than 12 meters. However, in wider and crowded streets, the lighting poles are placed on two sides of the roads. There may even be a third side of the lighting poles in the middle of the roads. In addition, corners, crossroads, and curved sections of the streets need additional considerations in placing lighting poles.

## Task

The task of each team is to:

- Decide appropriate distance between successive lighting poles by considering energy efficiency, minimising light pollution, and safety. Make your decisions based on your measurements from the light sensors. Observe and measure different choices and record them before making a decision.
- Write and share a report defending your decisions.

## Technical Information

Illuminance depends on three factors: the intensity of light source ( $I$ ), the distance between the light and the surface ( $d$ ), and the angle of the surface ( $\theta$ ). Mathematically, we can show their relationship with the formula:

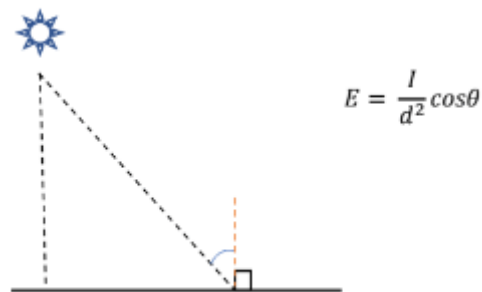

In other words, if the mounting height of the lighting poles increases, the illuminance decreases. If the distance between successive lighting poles increases, the illuminance decreases.

## Prerequisite Skills

- Basic understanding of the illuminance
- Basic understanding of the factors that affect the illuminance
- Basic skills in using the simulation environment

## STEAM Learning Outcomes:

### Science

- Determine illuminance to minimise light pollution due to the spacing between lighting poles

### Technology

- Use a light sensor
- Use the simulation environment
- Record and analyse data through a spreadsheet application

### Engineering

- Make designs for placement of the lighting poles for appropriate street lighting

### Arts

- Make decisions about lighting pole placement

- Share lighting pole placement strategy
- Gain awareness on light pollution
- Gain awareness on energy consumption

#### Mathematics:

- Use properties of angles and circles
- Solve problems related to angles and circles

### Activity Process

Teachers are recommended to follow the following steps:

- Encourage students to carefully read the task statement and brainstorm about the placement of lighting poles around their neighbourhood. Ask students following questions:
  - Have you ever thought about the placement of lighting poles?
  - How can technicians and engineers decide where to locate the poles?
  - What can be the factors that affect the decisions of engineers on the placement of the lighting poles?
  - Do they locate lighting poles similarly on all streets?
- In this scenario, students will use previously designed lighting poles in the simulation environment. Ask students to develop ideas about the placement of the lighting pole at corners, crossroads, and curved sections of the roads by trying to light these areas on the streets.
- Encourage students to measure their trials, record data, and try to come up with rules for placing the light pole on the streets.
- Ask students to share their strategies and write a report explaining their placement rules and defending their strategies.

### Assessment

The following questions can be considered for formative assessment purposes.

- What should be the distance between successive lighting poles? Explain your reasoning.
- What are the factors that affect the spacing (the distance between successive lighting poles)?
- Where do you start placing the lighting poles in the given map?
- How do you place lighting poles at corners, crossroads, and curved sections of the roads?

The following are expected from students:

- Developing a strategy for placement of the lighting poles
- Sharing their reasoning and plan

### Career Connections

City and Regional Planning, Electric and Electronic Engineering, Environmental Engineering



## Materials

Pre-designed lighting poles in the simulation environment

A street plan in the simulation environment

## Related Resources and References

International Institute for Energy Conservation (IIEC). (2015). (tech.). *Energy Efficiency Guidelines for Street Lighting in the Pacific*. Retrieved from [http://prdrse4all.spc.int/system/files/energy\\_efficiency\\_guidelines\\_for\\_street\\_lighting\\_in\\_the\\_pacific.pdf](http://prdrse4all.spc.int/system/files/energy_efficiency_guidelines_for_street_lighting_in_the_pacific.pdf)

The City of Calgary. (2016). (rep.). *Design Guidelines for Street Lighting*. Retrieved from <https://www.calgary.ca/content/dam/www/transportation/roads/documents/traffic/traffic-signals-and-streetlights/design-guidelines-for-street-lighting.pdf>

The University of Iowa. (n.d.). *Statewide Urban Design and Specifications (SUDAS)*. Statewide Urban Design and Specifications (SUDAS) | RIO Iowa Project. <https://rio.urban.uiowa.edu/smart-planning-toolbox/statewide-urban-design-and-specifications-sudas>.

## Scenario 4: Designing Daylight Harvesting System

**Description:** Design a lighting system that will automatically turn on at night

**Theme:** Street Lighting in a Smart City

**Grade Level:** Middle Schools / Junior High Schools (Ages 10 to 14)

**Duration:** 2 class hours

### Real-Life Scenario Setting

Smart cities use energy-saving systems due to their sensitivity to environmental issues. Thus, DRDI has an intention to reduce the energy consumption of the street lighting system used in the city. They decided to build a daylight harvesting lighting system for the town. These systems are known for their features that take advantage of naturally available light and benefits to reduce energy consumption. Basically, the daylight harvesting lighting systems turn on or dim electric lighting by daylight availability. Using such a system in street lighting can result in a significant saving in electricity costs. Also, such a system is more convenient than old fashion traditional lighting system since there is no need to turn on or dim to lights. They are fully automated.

The daylight harvesting system employs light sensors to measure naturally available lighting in the environment. Based on data from the light sensor, the system decides automatically to turn on, off, or dim the light.

### Task

With your team, design a system that has a daylight harvesting lighting feature for the streets of the city. The system you will design is expected to

- turn on lighting when the daylight level is not enough to safely move on the streets -which means at the night,
- dim lighting level when necessary.

Table 1 indicates illumination percentages correspond to hours in a day. The illumination percentage should be 100% at each hour, and you should arrange the lighting level of the pole accordingly. Remember that the old lighting system turns on the light (as 100%) between 20.00 to 6.00.

Table 1. Daily illumination levels

Hour	Illumination percentage
19.00	100%
20.00	80%
21.00	40%

22.00	20%
23.00	0%
00.00	0%
01.00	0%
02.00	0%
03.00	20%
04.00	40%
05.00	80%
06.00	100%

Note. Hours and illumination percentages change according to location and season.

### Technical Information

An “if-then statement” (also known as a conditional statement) contains a hypothesis and a conclusion. “*If this happens, then that will happen*” is a conditional statement. A hypothesis in the conditional statement is the first part and starts with “*if.*” The second part begins with “*then,*” which is the conclusion. The conclusion is the result of a hypothesis.

### Prerequisite Skills

- Basic understanding of the energy saving
- Know about the factors that may affect the energy saving
- Use the simulation environment and sensors

### STEAM Learning Outcomes:

#### Science

- Understand the energy efficiency through the daylight harvesting system

#### Technology

- Use light sensor
- Use led
- Use branching module
- Create flowcharts in the simulation environment
- Develop and run an algorithm

#### Engineering

- Designs a daylight harvesting system

#### Arts

- Make decisions about lighting choices
- Gain awareness on energy consumption
- Gain environmental awareness

### Mathematics:

- Use conditional statements in logic (if-then statement/conditional statement)
- Calculate increase and decrease by percentages

### Activity Process

Teachers are recommended to follow the following steps:

- Encourage students to carefully read the task statement and brainstorm about possible solutions. Questions to consider for probing students' thoughts can be illustrated as follows:
  - Have you ever seen a daylight harvesting lighting system? Where can they be used in addition to the streets of the city?
  - How can we develop an algorithm to design a daylight harvesting lighting system? Which coding structure and hardware should be used? (if-then statement/conditional statement)
- Guide students to create their algorithms by using flowcharts in the simulation environment. In this phase, the significant points should be considered as follows
- Use light sensors to determine the light level to decide whether there is a need to turn on or dim lighting level
- Write an algorithm that decides if the illumination level is below %25, turn on a light level, otherwise dim the light level.
- After developing an algorithm, the significant points should be considered
- Executing the algorithm,
- Observe whether the code is working properly or not. If it is not working, go back to the flowchart module in the simulation environment to revise it and re-execute it.
- Ask students to share their algorithms.

### Assessment

The following question can be considered for formative assessment purposes.

- What should be the working hours of lighting poles? Explain your reasoning.
- What are the factors that affect the daylight harvesting lighting system?
- How does "if-then" statement work in the simulation environment?

The following are expected from students:

- Developing a strategy for designing a daylight harvesting lighting system
- Sharing their reasoning and plan

### Career Connections

City and Regional Planning, Electric and Electronic Engineering, Earth and Space Science, Environmental Engineering

### Materials

A Street Plan in the simulation environment

Light sensors

## **Related Resources**

*Daylight Harvesting for Commercial Buildings Guide for 2019 Building Energy Efficiency Standards*. California Lighting Technology Center. (2021, April 13).  
<https://cltc.ucdavis.edu/publication/daylight-harvesting-commercial-buildings-guide-2019-building-energy-efficiency-standards>.

## **References**

Papamichael, K. (2017). Adaptive Lighting for Energy-Efficient Comfort and Wellbeing. SID Symposium Digest of Technical Papers.

## Scenario 5: Designing Motion-Detected Lighting System

**Description:** Design a lighting system that will automatically turn on when motion is detected

**Theme:** Street Lighting in a Smart City

**Grade Level:** Middle Schools / Junior High Schools (Ages 10 to 14)

**Duration:** 2 class hours

### Real-Life Scenario Setting

Smart cities are sensitive to environmental issues and tend to use energy-saving systems. Thus, DRDI intends to enhance the street lighting system used in the city to reduce energy consumption and become more compatible with the environment. Therefore, they decided to improve the street lighting system by adding one more feature. Currently used the daylight harvesting lighting system was worked well in reducing energy consumption, but the system still can be improved. The daylight harvesting lighting systems turn on or dim electric lighting in accordance with the daylight availability, but this feature is not enough to control light pollution and save energy. Obviously, the streetlights being on all night causes light pollution and unnecessary energy consumption.

The streetlights can be turned on when someone walks on the street with the help of motion detected lighting system. The darkness of the night can be preserved by using such a system. Motion detected lighting systems have a simple working principle. This system turns on the lights when a movement is detected. Motion detection sensors are used in such systems.

### Task

With your team, design a lighting system with a motion detection feature for the streets of the city. The system needs to

- turn on lights when motion is detected and keep them on for a reasonable duration,
- dim lights when there is no motion around.

For advanced learners, these systems can be combined with a daylight harvesting system.

### Technical Information

An “if-then statement” (also known as a conditional statement) contains a hypothesis and a conclusion. “*If this happens, then that will happen*” is a conditional statement. A hypothesis in the conditional statement is the first part and starts with “*if.*” The second part begins with “*then,*” which is the conclusion. The conclusion is the result of a hypothesis.

### Prerequisite Skills

- Explain the energy saving
- Explain the factors that affect the energy saving
- Use the simulation environment and sensors

## STEAM Learning Outcomes

### Science

- Discuss the importance of economical use of lighting systems
- Explain the motion detected lighting system
- Understand how motion detection sensors work
- Explain light pollution

### Technology

- Using motion detection sensor
- Using led
- Using branching module
- Creating flowcharts in Idea environment
- Run the algorithm

### Engineering

- Make designs for a motion-detected lighting system

### Arts

- Gain awareness on energy consumption
- Gain environmental awareness

### Mathematics:

- Use mathematical logic (if-then statement)

## Activity Process

Teachers are recommended to follow the following steps:

- Encourage students to carefully read the task statement and brainstorm about possible solutions. Questions to consider for probing students' thoughts can be listed as follows:
- Have you ever seen motion detected lighting system? Where can we use such kinds of systems in addition to the streets of the city?
- How can we develop an algorithm to design the motion detected lighting system? Which coding structure and hardware should be used? (if-then statement/conditional statement)
- Guide students to open the simulation environment and create their algorithm by using flowcharts. In this phase, the significant points should be considered as follows
- Use motion detection sensors to determine whether there is a motion or not to decide to turn on or dim lights.
- Write an algorithm that decides if there is motion around the lighting pole, turn on a light and keep them for 2 minutes.
- Save the flowchart.
- The last step is on the simulation environment. Guide students to open the simulation program and import the given environment that contains the street environment described in the problem statement and their flowchart to run the simulation. In this phase, the significant points should be considered as follows:
  - Importing the flowchart that contains the algorithm,
  - Executing the code,
  - Observing whether the code is working properly or not.

## Assessment

The following question can be considered for formative assessment purposes:

- What should be the working hours of lighting poles? Explain your reasoning.
- What are the factors that affect the motion-detected lighting system?
- What is the concept of energy-saving? Explain it by using your words.
- Why is energy-saving important? Explain your reasoning.
- What are your strategies for saving energy?
- How if-then statements in the simulation environment works?

The following are expected from students:

- Developing a strategy for designing a motion-detected lighting system
- Developing a strategy for saving energy
- Sharing their reasoning and plan

## Career Connections

City and Regional Planning, Electric and Electronic Engineering, Earth and Space Science, Environmental Engineering

## Materials

- The Street Map
- Motion detection sensors



## Scenario 6: Light Like an Egyptian

**Description:** Manipulate mirrors to bring light to dark areas

**Theme:** Street Lighting in a Smart City

**Grade Level:** K-2

**Duration:** 15 – 20 Minutes  
(Within the attention span duration of the target age group)

### Real-Life Scenario Setting

Smart City municipality needs your help! City counsellors had discussed the effective ways to improve its residents, and The Smart City Master Plan (SCMP) was developed considering their reviews and the residents' needs. Did you ever walk on a poorly lighted street, too dark or too bright than you need to see your environment? During the night-time, the city wants to use mirrors to bring light to dark areas.

The Ancient Egyptians understood some scientific uses of mirrors, redirecting sunlight down into pyramids to provide light for workers in the dark tombs.

### Task

Use mirrors to make dark areas light up!

### Prerequisite Skills

Ability to use the simulation environment

### STEAM Learning Outcomes:

#### Science

- Discuss the importance of the economical use of lighting devices.
- Explain how light reflects on mirrors.
- Examine what happens when you block a light source. Explore shadows.
- Determine how the angle of light changes the shadows of the objects.

#### Technology

- Use the simulation environment.

#### Engineering

- Make designs for mirrors and mirror placement.

#### Arts

- Gain awareness of how light reflects on surfaces.
- Observe shadows.
- Manipulate light and shadows using mirrors.

#### Mathematics:

- Explain the geometry of reflections.

## Activity Process

Teachers are recommended to guide students through the following steps:

- Manipulate the mirrors to make light reach one of the dark areas.
- Observe the shadows and how the angle of light changes them (make them long or short, also make them stronger or completely disappear).
- Make the light beam go around obstacles to reach the dark areas on the map.
- Make sure the light is strong enough to make the buzzer go.



Figure: An example of the use of mirrors.

## Assessment

- Teachers can bring the experience to real-life classroom by bringing mirrors and replicating the experiments.
- Prepare transparent, semi-transparent, matte, and reflective surfaces and let the children experiment with and discuss which surfaces reflect the light and which ones do not.

The following question can be considered for formative assessment purposes.

- What happens when you block the light (source)?
- What happens to shadows when you change the light's location?
- What can we do to make the buzzer activated (light sensor + buzzer module)?
- How can we make this dark corner in our classroom bright?

## Career Connections

City and Regional Planning, Electric and Electronic Engineering, Software Engineering, Environmental Engineering

## Materials

- The simulation environment
- Light sensors
- The Buzzer Module

### Related Resources

Brooklyn Museum. (n.d.). *Mirror: Egyptian, Classical, Ancient Near Eastern Art*.  
<https://www.brooklynmuseum.org/opencollection/objects/4068>.

Museum, T. T. o. t. B. (2016, November 09). Ancient Egyptian Mirror. *World History Encyclopaedia*. Retrieved from  
<https://www.worldhistory.org/image/6036/ancient-egyptian-mirror/>

### References

Mayesky, M. (2011). *Creative activities for young children*. Nelson Education.

Worth, K., & S. Grollman. (2003). *Worms, shadows, and whirlpools: Science in the early childhood classroom*. Portsmouth, NH: Heinemann.

## Theme – Waste Collection in a Smart City

One of the essential steps in The Smart City Master Plan is to renew and improve the old waste management system. The aim is to make the waste management more efficient and productive with the advance in technology. Considering the millions of tons of waste generated daily and their negative influence on the environment, waste management is a vital issue for the city to control, collect, utilize, process, transport, and dispose of waste economically and effectively. As a part of the waste management, the municipality stated that they want to begin designing and using a smart waste collection strategy. Therefore, they have cooperated with experts to propose a waste collection strategy based on the features of the collection zone (e.g., population density, types of buildings), frequency of collection, and public opinions about collection methods for improving living conditions and supporting environmental sustainability.

In your neighbourhood, seven garbage bins were placed in public places and in front of households. The waste in these bins generally includes organic or inorganic solid or liquid materials resulting from household activities, residential and non-residential buildings. According to municipality officials, waste collection in this area usually takes place at least twice a week. However, the bins are overfull due to the increase in population and the waste every day. Improper waste management system makes a severe health risk and leads to the spread of infectious diseases and pollutes the surrounding environment. Many serious harms such as the spread of diseases, health problems, and pollution can result from improper waste management. Besides, if the garbage bin has not been cleaned for a long time, rapid decomposition of food residue or waste and several organic waste combinations yield toxic gases such as methane (greenhouse gas). On the other hand, in some areas where population density is low, waste collection is not needed as often as in the other part of the district.

Accordingly, the municipality spends a decent amount of money on the old waste collection. Additionally, it is an issue to regularly control the waste bins because of their distant locations or difficulty in accessing them. Thus, the main objective is to collect waste on time and economically by minimizing the collection cost and sustaining energy savings. To reach this goal, the municipality wants to generate a waste management system that delivers prior alerts when the waste bins are full and warns the municipal waste management centre to clean the waste bin at the right time and prevent health and environmental problems.

## Scenario 7: Touch-Free Waste Container Design

**Description:** Create a touch-free waste container that will meet the particular design and aesthetic requirements

**Theme:** Waste Collection in a Smart City

**Grade Level:** Middle Schools / Junior High Schools (Ages 10 to 14)

**Duration:** 2 class hours

### Real-Life Scenario Setting

The first step of implementing a new waste collection system is to design a waste container for public areas. The proposed design for the waste bins should work efficiently at the public level by collecting organic or inorganic solid (and even liquid) materials to maintain a clean environment in a smart way. The appearance and design of the bin are important for a high-quality service of waste management. Ineffective design of the waste containers, such as too small sizes or trapping rainwater during wet days, can cause major problems and reduce waste collection efficiency. Also, the bin's design matters for taking the attention of all citizens, raising awareness for handling waste properly, and changing people's behaviour towards recycling. Additionally, the design of openings of the container should be functional for the protection of waste from insects, rain, or snow. Thus, it may be good to have waste containers have lids that open and close automatically.

The city municipality plans to put a preliminary design of waste containers into pilot use for one or two months. When designing your waste bin, it is required to maximize the quality of waste bins in terms of user utility, demands, desires, and needs, as well as the practical, functional, and aesthetics features. Consequently, the new waste containers should be hygienic, convenient, attractive, protecting the waste content, sensitive to human health and safety conditions, and be easily handled by the people and employees of the waste management services.

### Task

With your team, you are expected to design a waste container that has the following design and aesthetic principles.

- Decide on the physical properties of waste containers in terms of
  - *The capacity:* required storage volume, size, or dimensions (height, length, and width) of the container. Explain your reasoning.
  - *Shape or form* (any geometric shape available in the simulation environment, minimize floor space while respecting the height of users and restrictions of the fire service).
  - *Construction material* (plastic constitutes the most common material, but it can also be made of aluminium, metal, stainless steel, etc.) based on the location-based restrictions and conditions (inside and outside) such as prevention of the reactions)
  - *Appearance* (colour suitable for night vision, paintings, sketch, language)

- Develop an algorithm that will open the lid of the container automatically when anyone reaches it.

### Prerequisite Skills

Basic use of sensors and the simulation environment

### STEAM Learning Outcomes

#### Science

- Explain the importance of proper waste collection for environmental sustainability
- Explain chemical changes in waste containers.

#### Technology

- Using distance sensor
- Creating flowcharts in the simulation environment
- Create and run an algorithm in the simulation environment

#### Engineering

- Design a waste container that opens its lid automatically when you reach near the bin.

#### Arts

- Develop awareness of the importance of waste management in cities.
- Use artistic skills for designing a waste bin

#### Mathematics

- Define the dimension of a container in terms of height, length, and width
- Calculate the volume of a geometric solid

### Activity Process

Teachers are recommended to follow the following steps:

- Encourage students to read the task statement and brainstorm about possible solutions carefully. Questions to consider for probing students' thoughts can be listed as follows:
  - Have you ever used touch-free waste bins? For example, have you ever used touch-free waste bins with a foot pedal? What are the pros and cons of using touch-free waste bins?
  - How can we enhance waste bin design by using technology? Which sensors can be employed for this design?
- First, students need to decide on the physical properties of the waste containers using the alternative options in the simulation environment.
- After designing a bin, guide students to use the simulation environment to write an algorithm that reads inputs from distance sensors and opens the waste container's lid.
- Students should run the simulation by executing the code and observe whether the code is working properly or not. If it is not working, go back to revise it and re-execute it.
- Make students share their reasoning and solution strategy.

## Assessment

The following question can be considered for formative assessment purposes.

- What criteria would be important for an appropriate design of a waste container for outdoor use? Why?
- Why is the capacity of a waste bin important?
- Why is the shape of a waste bin important?
- Why is the construction material of a waste bin important?

The following are expected from students:

- Design a waste container based on specified practical and aesthetic variables or parameters
- Develop a touch-free waste bin whose lid automatically opens when someone approaches it.
- Share their team's design with others effectively and clearly.

## Career Connections

Electric and Electronic Engineering, Environmental Engineering, Chemistry Engineering

## Materials

Street map, Distance sensors

## References

Burguillos, J. D., & Caldoná, E. B. (2020). Design and development of a novel waste container from HDPE-layered bins. *Journal of King Saud University-Engineering Sciences*, 32(1), 85-90. <https://doi.org/10.1016/j.jksues.2018.06.002>

Keramitsoglou, K., & Tsagarakis, K. (2018). Public Participation in Designing the Recycling Bins to Encourage Recycling. *Sustainability*, 10(4), 1240. <https://doi.org/10.3390/su10041240>

## Scenario 8: Detecting the Current Filling Level

**Description:** Design a smart bin that will measure the level of waste in it and that will give a warning if the level of waste reaches the threshold limit

**Theme:** Waste Collection in a Smart City

**Grade Level:** Middle Schools / Junior High Schools (Ages 10 to 14)

**Duration:** 2 class hours

### Real-Life Scenario Setting

Old waste bins are not monitoring the waste inside in terms of their fill levels. If the waste is collected too late, this causes overflowing of waste bins, tipping due to overloading, burning, effluviating, and resulted with health and environmental problems. In addition, collecting waste too late creates economic difficulties for municipalities since overflowing waste bins lead to additional costs related to collecting and cleaning the surrounding area. On the other hand, if the waste is collected too early, this saves the time, labour force, resources, and money. Therefore, collecting the waste on time is critical for municipalities to prevent health-related, economic, and environmental problems if the waste is collected too late or too early.

Due to these potential problems of collecting waste and using old waste bins, the municipality decided to develop a system that prevents fill-level-related problems. They want to place sensors inside the bins that measure the level of waste and notify if the level of waste reaches the threshold limit. With this monitoring system, they can optimize waste collection schedules, accordingly, save money, time, and resources.

### Task

Your team will design a waste bin that

- measures the fill-level,
- if the fill-level is above a certain threshold, it will give a notification (e.g., play a sound or turn on a led).

### Prerequisite Skills

Basic use of sensors and coding skills in the simulation environment.

### STEAM Learning Outcomes

#### Science

- Explain health and environmental diseases related to waste

#### Technology

- Use ultrasonic sensor
- Use led or buzzer module
- Use branching module
- Use motor module
- Create and run an algorithm in the simulation environment.



### Engineering

- Design a control system to see if the fill level is above the threshold value.

### Arts

- Develop awareness of the importance of waste management in cities.
- Explain the effect of waste on the environment, public health, and economy.

### Mathematics

- Use inequalities in algorithms

## Activity Process

Teachers are recommended to follow the following steps:

- Encourage students to read the task statement and brainstorm about possible solutions. Questions to consider for probing students' thoughts can be:
  - Have you ever noticed that waste bins smell bad, or leachate spread from the bins? What can be the reason for this problem? What can be the results of this problem?
  - Have you ever noticed any garbage trucks in your neighbourhood? How can they decide their route? When do they collect the waste? If they collect the waste too late, what can be the results? If they collect the waste too early, what can be the results?
  - How can we develop an algorithm to measure the waste level inside of the bin?
  - How can we develop this algorithm to alert when the level of waste in the bin (fill-level) reaches 75%?
- Guide students to create such a waste bin. They need to write an algorithm that gives a notification when the fill-level reaches a certain level (e.g., 75%).
- This activity can be a good opportunity to make students think about the repetition of the tasks that have already been done in previous steps. Therefore, repetition codes, namely the loop structures, can be focused on here.
- Ask students to share their reasoning and solution strategy.

## Assessment

The following question can be considered for formative assessment purposes.

- Why is the fill-level of a waste bin important?
- What criteria would you use for a warning system? Explain your reasoning in detail.

The following outcomes are expected from students:

- Develop a control system in terms of fill-level for a waste bin.
- Develop a waste bin alert system for a single bin.
- Share his/her plan and model effectively and clearly.

## Career Connections

Electric and Electronic Engineering, Environmental Engineering, Chemistry Engineering

## **Materials**

The simulation environment and its modules.

## **References**

Dhinagar, P., Vijey, A., & Ram, S. (2018). Smart garbage bin. *International Journal of Advanced Research, Ideas, and Innovations in Technology*, 4(5), 693-695.

## Scenario 9: Monitoring Movement of Waste Bin

**Description:** Design a smart bin that will monitor its movement and that will give a warning when detecting any movement

**Theme:** Waste Collection in a Smart City

**Grade Level:** Middle Schools / Junior High Schools (Ages 10 to 14)

**Duration:** 2 class hours

### Real-Life Scenario Setting

To handle the environmental problems raised by ineffective waste collection and disposal, the first step of the new waste collection system is to smarten the waste containers and bins used in public places. In addition to the monitoring system that displays waste bins' fill-level and temperature changes, the smart bin is likely to be capable of detecting any movement of the waste bin. It may be encountered that waste bin or container is down because of vandalism, animals, accidents, or the wind. This can cause some environmental problems, health issues, and accidents on public roads.

In order to preserve the number and placement of waste bins and containers, the municipality plan to detect movement of the container in a given position and placement. Using tilt and acceleration sensors, it is possible to know when the container has been moved or overturned.

### Task

Your team will design a smart waste bin that can

- sense any movement, both horizontal and vertical.
- give an alarm or notification if it detects the movement or whether the bin has fallen down

### Technical Information

**Accelerometers** are the instruments that measure acceleration forces on an object. Acceleration is the rate of change in the velocity of an object. The acceleration forces may be static, like the constant force of gravity, or dynamic, causing the accelerometer to move or vibrate. Accelerometers measure in units of *meters per second squared* ( $m/s^2$ ) or in *G-forces* ( $g$ ). The average single G-force on planet Earth is equivalent to  $9.8 m/s^2$ , but this has a different value on other planets. Accelerometers are useful for sensing vibrations in systems or for orientation applications. Accelerometers can measure acceleration on one, two, or three axes. It can produce either analogue or digital outputs. Analog-style accelerometers output a continuous voltage that is proportional to acceleration. e.g., 2.5V for 0g, 2.6V for 0.5g, 2.7V for 1g. Digital accelerometers usually use pulse width modulation (PWM) for their output. This means there will be a square wave of a certain frequency, and the amount of time when the voltage is high will be proportional to the amount of acceleration.

## Prerequisite Skills

Basic use of sensors and basic coding skills

## STEAM Learning Outcomes

### Science

- Explain the importance of proper waste collection for environmental sustainability
- Explain the concept of motion
- Explain the terms of displacement, distance, velocity, and acceleration.
- Explain gravitational forces.

### Technology

- Use tilt or accelerometer sensor
- Create and run an algorithm

### Engineering

- Use engineering design processes to create a smart waste container that will monitor the bin's movement.

### Arts

- Develop awareness of the importance of waste management in cities.
- Explain the effect of waste on the environment, public health, and economy.

### Mathematics

- Describe the Cartesian coordinate system
- Identify the position of any point by using its Cartesian coordinates

## Activity Process

Teachers are recommended to follow the following steps:

- Encourage students to read the task statement and brainstorm about possible solutions. Questions to consider for probing students' thoughts can be:
  - Have you ever seen that waste bins are turned down, and garbage spreads around or on the road? What can be the reason for this problem? What can be the results of this problem?
  - How can we detect the movement of the bin?
  - How can we develop an algorithm to detect and notify when the bin or container moves or fallen down?
- Guide students to write an algorithm that monitors waste bin's movement and gives notification when it moves (e.g., play a sound, show a text, or turn on a led).
- This activity is a suitable one to talk about loop structures in algorithms. Please discuss this issue with the students if necessary.
- Make students share their solution strategies.

## Assessment

The following questions can be considered for formative assessment purposes.

- Is it essential to monitor the movement of a waste bin? Why? Or why not?
- How can you detect the movement of a waste bin?
- What criteria would you use for a warning system? Explain your reasoning in detail.

The following are expected from students:

- Develop a waste bin with a movement detection system.
- Share their team's device with others effectively and clearly, explaining their reasoning in their choices.

### **Career Connections**

Electric and Electronic Engineering, Environmental Engineering, Chemistry Engineering

### **Materials**

The simulation environment and accelerometer sensors

### **Related Readings**

Singh T., Mahajan R., & Bagai D. (2016). Smart Waste Management using Wireless Sensor Network, *International Journal of Innovative Research in Computer and Communication Engineering*, 4(6), pp. 10343–10347.

### **References**

Ecube Labs. (2018, June 4). Fullness Monitoring for Waste: How Do the Technologies Compare? <https://www.ecubelabs.com/fullness-monitoring-for-waste-how-do-the-technologies-compare/>.

OMEGA Engineering. (2021). *Accelerometer: Introduction to Accelerometers*. <https://www.omega.co.uk/prodinfo/accelerometers.html>.

Papalambrou, A., Karadimas, D., Gialelis, J., & Voyiatzis, A. G. (2015, September). A versatile scalable smart waste-bin system based on resource-limited embedded devices. In *2015 IEEE 20th Conference on Emerging Technologies & Factory Automation (ETFA)* (pp. 1-8). IEEE.

SparkFun Electronics. (2021). *Accelerometer Basics*. <https://learn.sparkfun.com/tutorials/accelerometer-basics/all>.

WasteHero. (2020). Smart Waste Management Driven by IoT. <https://www.wastehero.io/en/>.

Zhao, Y., Yao, S., Li, S., Hu, S., Shao, H., & Abdelzaher, T. F. (2017). VibeBin: A vibration-based waste bin level detection system. *Proceedings of the ACM on Interactive, Mobile, Wearable and Ubiquitous Technologies*, 1(3), 1-22. <https://dl.acm.org/doi/pdf/10.1145/3132027>

## Scenario 10: Optimizing Smart Waste Monitoring System

**Description:** Design a system that will monitor fill-level, temperature, and movement of waste bins in a given street and schedule the waste collections.

**Theme:** Waste Collection in a Smart City

**Grade Level:** Middle Schools / Junior High Schools (Ages 10 to 14)

**Duration:** 2 class hours

### Real-Life Scenario Setting

The city officials have already qualified waste bins with several features to waste bins to develop a smart collection system to make the waste management/collection processes environmentally friendly, safe, and economical. In detail, three innovative features have been included in the system. The first one was a feature that controls the movements of waste bins against the risk of falling or removal due to vandalism, animals, or the wind. The second was a feature that checks the fill-level of waste bins and warns when the bins are full. The third feature was designed to monitor the temperatures of waste bins and warn if the temperature exceeds the threshold.

Although these three independent systems have been working effectively, having them to manage waste collection is not smart enough. It has become more and more time-consuming and inconvenient for the officers' work in the waste collection centre. Therefore, as a final step to a smart waste management system, the municipality decided to create a comprehensive system that brings all these three features in one.

### Task

Together with your team, develop an algorithm that

- monitors all the waste bins in the neighbourhood (use the map on the simulation environment)
- reads inputs of three features (fill level, temperature, and movement) from all waste bins to help optimise waste collection
- decides when to make an alarm or notification (e.g., play a sound/turn on a led) to pay attention to the waste bins.

### Prerequisite Skills

Basic coding skills

### STEAM Learning Outcomes

Science

- Explain health and environmental diseases related to waste

Technology

- Create and run an algorithm that uses loop structures and Boolean expressions.

### Engineering

- Design a system to monitor three independently working waste management systems
- Explain the importance of user-friendly software design

### Arts

- Develop awareness of the importance of waste management in cities
- Explain the effect of waste on the environment, public health, and economy

### Mathematics

- Use inequalities and logical operations to make decisions for solving problems
- Collect and analyse data

## Activity Process

Teachers are recommended to follow the following steps:

- Encourage students to read the task statement and brainstorm about possible solutions. Questions to consider for probing students' thoughts can be:
  - How can we develop an algorithm to control inputs comes from three independent working systems simultaneously? Which code structure could be used?
  - Have you ever heard about user-friendly software design?
  - Have you ever used Boolean expressions? Could you give an example to any Boolean expressions?
  - Have you ever used if-then structure/branching expression? How can we use this expression in this situation?
  - Have you ever used the loop (repetition) structure? How can we use this expression in this situation, considering there is more than one waste bin in the neighbourhood?
- Guide students to write an algorithm that reads inputs from sensors of each waste bin and notifies when they need attention.
- Make students share their solution strategy and reasoning.

## Assessment

The following questions can be considered for formative assessment purposes.

- Which coding structures can be used for repetitive tasks?
- Which coding structures can be used when there is more than one if condition?
- Could you give an example of a system that does not have a user-friendly interface?

The following outcomes are expected from students:

- Develop a monitoring system by using Boolean logic and loop structures.
- Share his/her algorithm effectively and clearly.

## Career Connections

Software Developing, Data Scientist, Environmental Engineering

## **Materials**

The simulation environment

## **References**

Durrani, A. M. F., Rehman, A. U., Farooq, A., Meo, J. A., & Sadiq, M. T. (2019, February). An automated waste control management system (AWCMS) by using Arduino. In *2019 International Conference on Engineering and Emerging Technologies (ICEET)* (pp. 1-6). IEEE.



## **Theme – Mission to Mars**

Scientists have been trying to understand and clarify whether life exists on other planets for many years. After their research, many scientists have built a consensus on exploring Mars, the Red Planet, to answer their fundamental questions regarding life beyond Earth. There are several scientific, economic, and technological reasons behind this consensus on exploring Mars. Mars is a valuable planet for exploration since it is quite similar to the Earth, scientists have knowledge and data related to mapping it, and it can be reached in almost six months. For example, The European Space Agency (ESA) identified scientific reasons as (i) the search for life, (ii) understanding the surface and the planet's evolution, and (iii) preparing for future human exploration.

Also, scientific explorations addressed that although Mars is dry, cold, and has a thin atmosphere at present, it had exactly the opposite characteristics, namely watery, warm, and thicker atmosphere. Scientists argued that Mars could be habitable in the past, so they want to investigate it.

## Scenario 11: Designing a Mars Rover

**Description:** Design a Mars Rover that can autonomously navigate on the Mars surface.

**Theme:** Mission to Mars

**Grade Level:** Middle Schools / Junior High Schools (Ages 10 to 14)

**Duration:** 2 class hours

### Real-Life Scenario Setting

Over the years, scientists have been designing and using different types of spacecrafts for different purposes to explore the red planet. For example, orbiters have taken pictures around Mars while landers have delivered significant information and photographs from their landing areas. On the other hand, scientists have designed rovers that have wheels and drive around without difficulty to different areas on the surface of Mars to get more information about the different parts of the planet and study the different types of rocks and chemicals in each rock on Mars. To explore Mars, the National Aeronautics and Space Administration (NASA) has sent five rovers so far: Sojourner, Spirit and Opportunity, Curiosity, and Perseverance.

The Mars Mission aims to understand the Martian geological evolution and gather scientific information concerning colour images, compositions, chemical properties, and magnetic properties of rocks and other materials on the red planet. Thus, the Mars Rover, a special space vehicle designed to explore the Martian surface and collect samples, is used to achieve this goal. The rover should be able to navigate on the Mars surface autonomously. However, this is not a straightforward task. It is known from the previous Mars missions that Mars planet has a rough surface with several rocks, trenches, and craters. Therefore, the rover requires a sophisticated navigational system that detects and avoids hazardous terrains such as large rocks, trenches, or dunes.

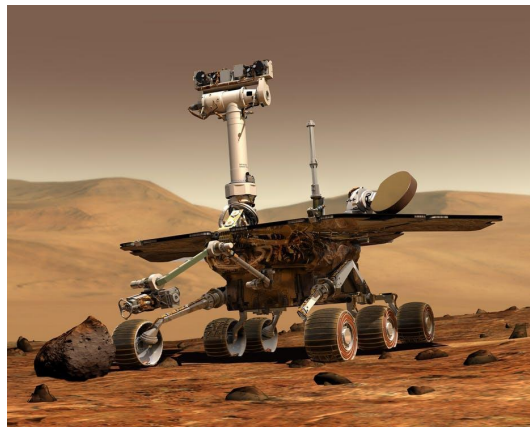

Mars Rover

## Task

Suppose you will be working as an engineering team member at the Mars Mission Program to design a rover for this mission. Your responsibility is to develop an autonomous navigational system and keep the rover stable with features of obstacle-detection and avoidance.

Your task is to create an algorithm that enables the rover to detect rocks from a distance of about 80 centimetres and avoid them by turning the rover 45 degrees.

## Technical Information

When a vehicle is moving, it can move forward/backward or turn right/left. The vehicle's movement depends on a mechanism of the wheels and steering wheel that work based on angles to act. An angle can be defined as the space created between two rays connected at a common point in geometry. Angles are measured in degrees and represented by the  $^{\circ}$  symbol. The quantity of degrees indicated how open or closed the angle is.

An angle whose measure is more than  $0^{\circ}$  but less than  $90^{\circ}$  is called an acute angle. An angle whose measure is  $90^{\circ}$  is called a right angle. An angle whose measure is greater than  $90^{\circ}$  but less than  $180^{\circ}$  is called an obtuse angle. An angle whose measure is  $180^{\circ}$  is called a straight angle. An angle whose measure is more than  $180^{\circ}$  but less than  $360^{\circ}$  is called a reflex angle. An angle whose measure is  $360^{\circ}$  is called full rotation.

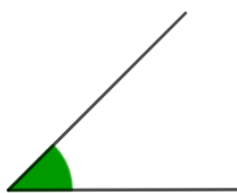

**Acute Angle**  
Greater than 0 degree  
and less than 90 degree

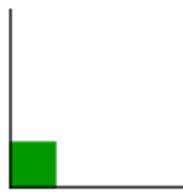

**Right Angle**  
Exact 90 degree

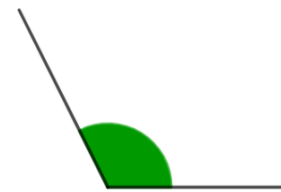

**Obtuse Angle**  
Greater than 90 degree  
and less than 180 degree



**Straight Angle**  
Exact 180 degree

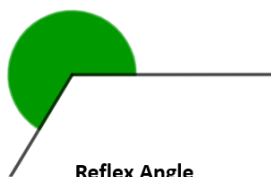

**Reflex Angle**  
Greater than 180 degree  
and less than 360 degree



**Full Rotation**  
Exact 360 degree

Types of Angles

## Prerequisite Skills

Basic use of sensors and coding skills.

## STEAM Learning Outcomes:

Science

- Explain the relationship between advances in technology and research in space science.

### Engineering

- Use the engineering design process to develop an algorithm.

### Technology

- Use obstacle detector
- Use decision/branching algorithms
- Create and run an algorithm
- Understand how obstacle sensors are working

### Arts

- Prepare material for sharing (video/presentation /poster/paper) related to their Mars Mission

### Mathematics

- Solve problems related to angles
- Solve problems related to circles

## Activity Process

Teachers are recommended to follow the following steps:

- Encourage students to read the problem statement and brainstorm about possible solutions. Questions to consider for probing students' thoughts can be:
  - Think and discuss how to navigate the rover on a rough Martian surface without crushing and being overturned. Which sensors can be used to escape from this situation?
  - How are the obstacles sensors working? Could you give an example from your daily lives (e.g., cleaning robots) that use obstacle sensors?
  - Discuss how many sensors are necessary to drive on such surfaces safely and where they should be located.
- Guide students to open the simulation environment and create their algorithm by using flowcharts. In this phase, the significant points should be considered as follows:
  - Use the motor module to navigate your rover through the surface.
  - Use obstacle sensors to determine the positions of obstacles.
  - Write an algorithm that decides if the distance between the obstacle and the rover is below 5 meters, turn the rover 45 degrees to another direction.
- The last step in the simulator is to run their algorithms. In this phase, students should be encouraged to observe whether the code is working properly or not. If not, go back and revise it and re-execute it.
- Write a report that in which points there is an obstacle and in which points do not.

## Assessment

The following outcomes are expected from students:

- Develop an algorithm that can detect obstacles.
- Their algorithms can turn the rover about 45 degrees towards another direction in case of an obstacle.

## Career Connections

Earth and Space Science, Geology, Astronomy

## Materials

The simulation environment and a map of the Mars surface to work.

## Related Resources & References

Bybee, R. W. (1998). Bridging Science and Technology. *The Science Teacher*. 38-42.  
[http://people.uncw.edu/kubaskod/SEC\\_406\\_506/Classes/Class\\_4\\_TechnoLiteracy/Bridging\\_Science\\_Technology.pdf](http://people.uncw.edu/kubaskod/SEC_406_506/Classes/Class_4_TechnoLiteracy/Bridging_Science_Technology.pdf)

Lumen. (2021). *The Geology of Mars*. Earthlike Planets: Venus and Mars.  
<https://courses.lumenlearning.com/astronomy/chapter/the-geology-of-mars/>.

NASA. (2019, September 12). *Mars Curiosity Rover: Goals*. Mars Exploration Program.  
<https://mars.nasa.gov/msl/mission/science/goals/>.

NASA. (2020, September 11). *Mars Curiosity Rover: Summary*. Mars Exploration Program.  
<https://mars.nasa.gov/msl/spacecraft/rover/summary/>.

NASA. (2021, February 25). *Student Project: Explore Rocks Using Core Sampling*. Jet Propulsion Laboratory.  
<https://www.jpl.nasa.gov/edu/learn/project/explore-rocks-using-core-sampling/>.

The European Space Agency. (2021). *Why go to Mars?*  
[https://www.esa.int/Science\\_Exploration/Human\\_and\\_Robotic\\_Exploration/Exploration/Why\\_go\\_to\\_Mars](https://www.esa.int/Science_Exploration/Human_and_Robotic_Exploration/Exploration/Why_go_to_Mars).

## Scenario 12: Collecting Rock Samples

**Description:** Design a device that will collect some rock samples from the surface of Mars.

**Theme:** Mission to Mars

**Grade Level:** Middle Schools / Junior High Schools (Ages 10 to 14)

**Duration:** 2 class hours

### Real-Life Scenario Setting

The Mission to Mars Program aims to understand the Martian geological evolution and gather scientific information concerning colour images, compositions, chemical properties, and magnetic properties of rocks and other materials on the red planet. To reach this goal, the first step of the investigation includes collecting rock samples from the surface of Mars and analysing them to find crucial evidence of the early history of Mars. Such evidence is mostly related to humidity, the presence of water, chemical elements included in rocks, microbial findings on rocks.

The findings derived from the observations and evidence have characterized the idea that life on Mars would lead to some changes in the rocks or soil. Scientists examined the rock samples to acquire information about what they are made of and how and when they were formed. There are three types of Earth rocks: igneous (e.g., meteorites), sedimentary, and metamorphic rocks. Scientists are still trying to learn about these rock types on Mars. The characteristics of the rocks embody their composition and appearance.

Igneous rocks have limited ability to provide a piece of evidence regarding biological activity on Mars. On the other hand, scientists are particularly studying a kind of sedimentary rock, conglomerate, which consists of small gravels of other types of rocks. The analysis of the layers and the materials inside conglomerate can give a hint about the history of Mars, indicating water once eroded, or flooded in the past. Consequently, they look for evidence of rock layers that formed in the presence of water. Scientific evidence points out that, if there was once water, there might have been life on Mars. To look for the possibility of past microbial life on the red planet, Mission to Mars Program aims to explore the sedimentary rocks such as conglomerates and gather such rock samples for analysis.

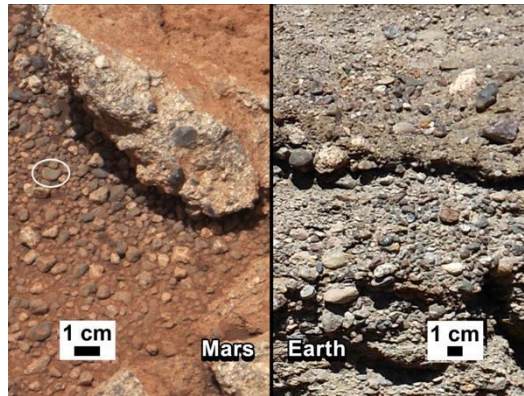

The images compare the outcrop of rocks on Mars (left) with similar rocks seen on Earth (right). The images obtained by NASA's Curiosity rover shows rounded gravel fragments, or clasts, up to a few centimetres, within the rock outcrop (credit: NASA/JPL-Caltech/MSSS and PSI)

Examination of the characteristics of rocks and soils also provides evidence for bio-signatures such as immediate changes in isotopic abundance of the chemical elements that might be linked with life on Mars or changes in the Martian atmosphere through time. For example, determining the form and amount of the isotopes<sup>1</sup> of elements like carbon found on the planet present compelling evidence about the environmental conditions of the planet for sustaining life. In general, the biological form includes elements with two or more stable isotopes, but the presence of many isotopes can be influenced by various situations such as environmental conditions, volcanic explosions, or excessive ultraviolet radiation.

The previous engineering team has successfully developed the rover that can autonomously navigate on the Martian surface to reach this goal. Now, it is time to update the rover to collect samples from the surface.

### Task

Suppose you will be working as an engineering team member at the Mars Mission Program to design the rover for this mission. Your responsibility is to develop an algorithm that gathers samples from Martian surface by using the rover's robotic arm. Your task is to develop an algorithm that can

- Use the movement of a robotic arm to gather rock samples from the Martian surface to the storage of the rover,
- Avoid duplicate rock samples (in order to increase the variety of collected rock samples, it is essential to check the rock type--represented by colours and avoid duplicates),
- Determine the colour and weight of the collected rock samples.

### Technical Information

#### For basic learners:

---

<sup>1</sup> Isotopes can be defined as the variants of a chemical element with the same atomic number and position in the periodic table but with different neutron number, and thus with different atomic masses.

Can you say the difference between mass and weight? Or are they the same?

Mass is the amount of matter, and it does not change with respect to position. For example, if you have 1 kg of rock and take it to Mars, its mass will still be 1 kg because there will be the same amount of rock on the Earth and Mars.

However, its weight will be different on Mars. Weight is the force that is caused by gravity. We can say that how much the planet applies force on the rock -toward itself shows the rock's weight. So, the weight of this rock will be different on Mars than on Earth.

We compare weights of the same rock on Earth and Mars with the following ratio:

$$\frac{\text{Weight on Mars}}{\text{Weight on Earth}} = \frac{3.7}{9.8}$$

Now, you can find the weight of 1 kg rock on Mars!

### **For advanced learners:**

Can you say the difference between mass and weight? Or are they the same?

Mass is the amount of matter, and it does not change anywhere. For example, if you have 1 kg of rock with you when you go to Mars, its mass still will be 1 kg there because there will be the same amount of rock on the Earth and Mars. However, its weight will be different on Mars. Let's first discuss what weight is. It involves mass and some other concept, the *universal law of gravitation*, which creates the difference between mass and weight.

Thanks to Newton and many other scientists, today, we know that any two bodies attract each other with a simple equation.

$$F = G \frac{m_1 m_2}{d^2}$$

$G$  is the *universal gravitational constant*, which is a constant number, and it equals to the force between 1 kg of two masses with 1 m distance. We know the magnitude of  $G$  ( $6.67 \times 10^{-11} \text{ Nm}^2/\text{kg}^2$ ), mass and radius of the Earth, so we can calculate the attraction between 1 kg rock and the Earth. Likewise, we know the mass and radius of Mars, so we can also calculate the attraction between 1 kg rock and Mars. As you can guess, these attractions are different, which indicates that the weight of 1 kg rock will be different on these planets.

Let's calculate the weight of the rock on the Earth and Mars' surfaces.

$$m_{\text{rock}} = 1 \text{ kg}$$

$$m_{\text{Earth}} = 6 \times 10^{24} \text{ kg}$$

$$d_{\text{Earth}} = 6.4 \times 10^6 \text{ m}$$

$$m_{\text{Mars}} = 6.4 \times 10^{23} \text{ kg}$$

$$d_{\text{Mars}} = 3.4 \times 10^6 \text{ m}$$



$$F = G \frac{m_1 m_2}{d^2}$$

Weight of 1 kg rock on the Earth's surface:

$$F = 6.67 \times 10^{-11} \frac{1 \times 6 \times 10^{24}}{(6.4 \times 10^6)^2}$$

$$F = 9.8 \text{ N}$$

Weight of 1 kg rock on Mars' surface:

$$F = 6.67 \times 10^{-11} \frac{1 \times 6.4 \times 10^{23}}{(3.4 \times 10^6)^2}$$

$$F = 3.7 \text{ N}$$

Now, you see the difference between mass and weight!

### Prerequisite Skills

- Basic coding skills
- Understand the basic properties of planets in the solar system

### STEAM Learning Outcomes:

#### Science

- Recognize the origin and evolution of Mars as a geological system.
- Recognize weight as the force exerted on a body by gravity
- Compare the mass and weight concepts.
- Explain gravity as gravitational force or interaction between celestial bodies.

#### Technology

- Create and run an algorithm that uses loop structures and Boolean expressions.

#### Engineering

- Use the engineering design process to develop an algorithm for a robotic arm to collect objects around.

#### Arts:

- Prepare a presentation, or a video demonstrates their robot's features and performance

#### Mathematics:

- Solve problems related to the conversion of units

### Activity Process

Teachers are recommended to follow the following steps:

- Encourage students to read the problem statement and brainstorm about possible solutions. Questions to consider for probing students' thoughts can be:
  - Think and discuss how to collect rock samples from the Martian surface.
  - Which paths can be used to reach rock samples?
  - At which point robotic arm should be moved forward to pick up rocks?

- Guide students to work on the simulation environment to create their algorithm by using flowcharts. In this phase, the significant points should be considered as follows:
  - Use the motor module to navigate your rover to rocks in the given map.
  - Use a weight and colour sensor to obtain the physical properties of rocks.
  - Write an algorithm that decides if the rock is unique in terms of its physical properties (consider only its colour) or not.
  - Use robotic arms to collect rocks.
- In the simulation environment, guide students to open the Martian surface environment and run the simulation. Observe whether the code is working properly or not. If it is not working, go back, revise, and re-execute it.
- Write a report that in the properties of collected rock samples by converting them with Earth measurement.

### Assessment

The following are expected from students:

Develop an algorithm that can:

- detect rock samples,
- determine its colour,
- collect the rock sample with the arm, if that colour has not already been collected,
- measure its weight and convert it to Earth measurement.

### Career Connections

Earth and Space Science, Computer Science, Geology, Astronomy

### Materials

The simulation environment, robotic arm, colour sensor

### Related Resources and References

Grady, M. M. (2020). Exploring Mars with returned samples. *Space Science Reviews*, 216(4), 1-21.

Lumen. (2021). *The Geology of Mars*. Earthlike Planets: Venus and Mars. <https://courses.lumenlearning.com/astronomy/chapter/the-geology-of-mars/>.

NASA. (2019, September 12). *Mars Curiosity Rover: Goals*. Mars Exploration Program. <https://mars.nasa.gov/msl/mission/science/goals/>.

The European Space Agency. (2021). *Why go to Mars?* [https://www.esa.int/Science\\_Exploration/Human\\_and\\_Robotic\\_Exploration/Exploration/Why\\_go\\_to\\_Mars](https://www.esa.int/Science_Exploration/Human_and_Robotic_Exploration/Exploration/Why_go_to_Mars).

## Scenario 13: Ready for Mars

**Description:** Prepare Mars for Human Habitation by using EUROver

**Theme:** Mission to Mars

**Grade Level:** K-2

**Duration:** 30 – 45 Minutes

### Real-Life Scenario Setting

The year is 2033! European Space Agency (ESA) has successfully landed a very advanced Mars rover called EUROver onto the Martian North Polar region where water is present as ice.

### Task

Your task: Prepare Mars for Human habitation by using EUROver. Clean up the surface area from the rocks for incoming settlements. You need to get orders from different partners and upload the instructions to the rover.

- Mission Type A: Clear rocks to create flat areas for habitation modules.
- Mission Type B: Inflate hi-tech inflatable habitation modules.
- Mission Type C: Decorate habitation modules (Users will be able to decorate the habitation modules).
- Mission Type D: Melt the ice to make water; then, store water for each habitation module.

### Prerequisite Skills

Ability to use the simulation environment.

### STEAM Learning Outcomes

#### Science

- Discuss the importance of space exploration.
- Discuss the requirements for human survival on other planets.
- Categorize the states of matter; experiment the melting of ice.

#### Technology

- Use the motor module to move and manipulate EUROver.
- Develop and run an algorithm.

#### Engineering

- Design habitable spaces on Mars surface.

#### Arts

- Explore the colours of the mars surface.
- Design and decorate the mars rover and habitation modules.

#### Mathematics:

- Use addition and subtraction to solve problems.

- Measure the area of the habitation modules based on the number of humans to be settled.
- Determine the amount of water required for each habitation module based on the number of humans to be settled.

### Activity Process

- Personalize EUROver design (Users will be able to select different stickers to decorate the rover).
- Receive instructions from different country space agencies (Partner countries will send instructions which need to be translated in the translation module – instructions will be recorded in each country’s language).
- Move EUROver to the mission sites.
- Mission Type A: Clear rocks to create flat areas for habitation modules.
- Mission Type B: Inflate hi-tech inflatable habitation modules.
- Mission Type C: Decorate habitation modules (Users will be able to decorate the habitation modules).
- Mission Type D: Melt ice to make water then, store water for each habitation module.



Example of a Mars surface map grid

### Assessment

Teachers can transfer the experience to real-life classrooms by creating an environment with different surface elements and helping children navigate these surfaces using self-designed vehicles.

Support children’s curiosity with drama activities where children enact living on the surface of Mars.

The following question can be considered for formative assessment purposes:

- What do we need to do to be able to live on the Martian surface?
- How can we make the ice melt?
- How much water do we need for  $x$  number of astronauts?
- How much space do we need for  $x$  number of astronauts?

## **Career Connections**

Aerospace Engineering, Electric and Electronic Engineering, Software Engineering, Robotics, Machine Learning, and Artificial Intelligence

## **Materials**

The simulation environment, colour sensors

## **Related Resources**

STEM Engagement at NASA: <https://www.nasa.gov/stem/about.html>

The European Space Agency: <http://www.esa.int/>

## **References**

Kupersmith, S., Kopack, M., & Johnson, R. (2016). *STEM Outreach Activities to Inspire Future Engineers and Scientists*.

Ng, C. H., & Adnan, M. (2018). *Integrating STEM education through Project-Based Inquiry Learning (PIL) in topic space among year one pupils*. In IOP Conference Series: Materials Science and Engineering (Vol. 296, No. 1, p. 012020). IOP Publishing.

## **Various Themes for Elementary Level**

## Scenario 14: Ocean Sparkle

**Description:** Clean river surface and floors

**Theme:** Environmental protection

**Grade Level:** K-2

**Duration:** 20 – 30 Minutes  
(Within the attention span duration of the target age group)

### Real-Life Scenario Setting

City Councillors have met to discuss the increasing pollution in Pearl River, a large waterway passing through the city. Millions of tons of plastic enter the oceans every year through rivers, and a portion of this plastic travel further to oceans creating huge patches and destroying sea life. If no action is taken, plastic will increasingly impact the city's ecosystems; this also negatively affect the economy and its citizens' health.

### Task

Your task is to design and operate water cleaning devices to keep the city river clean from plastic patches.

### Prerequisite Skills

Ability to use the simulation environment.

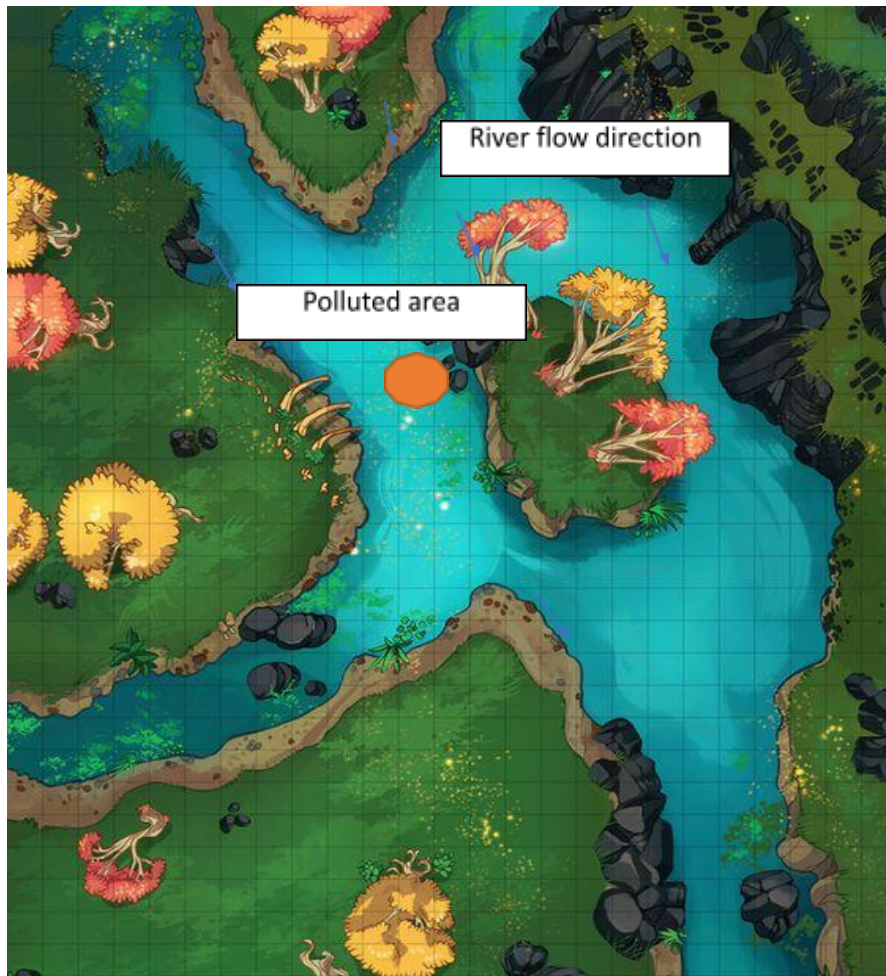

Sample River Map

### STEAM Learning Outcomes

#### Science

- Develop progressively more sophisticated explanations of natural phenomena.
- Recognize that populations live in a variety of habitats and change in those habitats affects the organisms' living there.
- Examine how water pollution occurs and what happens when plastic accumulate on rivers.

#### Technology

- Use proximity sensor.
- Use motor/movement module to move and manipulate a variety of devices.
- Code an algorithm and run it.

#### Engineering

- Improve existing technologies or develop new ones to increase their benefits and decrease known risks to meet societal demands.
- Define a simple design problem reflecting a need.



## Art

- Describe the colours of the oceans/ivers

## Mathematics:

- Describe measurable attributes of objects, such as length or weight.
- Use addition and subtraction within 100 to solve word problems involving lengths given in the same units.

## Activity Process

- Place boats with proximity sensors on the river,
- Be aware of the proximity sensor alerts for floating plastic patches on the river,
- Manipulate the cleaning boat near the polluted areas,
- Clean the polluted areas.

## Assessment

Teachers can bring the experience to real-life classrooms by utilizing water tables (or large containers), strainers, colanders toy boats/ships, and different textile/fabric and glitter types. Using these materials, children can develop effective ways to clean the water in the containers/water table.

The following question can be considered for formative assessment purposes.

- What does it mean when the buzzer/led go off?
- What do you do when the buzzer/led indicates a floating plastic patch coming down the river?
- What happens to all the plastic in the river if we do not clean it?
- What can we do to limit plastic use at home/school?

## Career Connections

City and Regional Planning, Software Engineering, Environmental Engineering

## Materials

The simulation environment, the proximity sensor module, the buzzer module, led modules

## Related Resources

PBS Saving the Oceans: <https://www.pbs.org/show/saving-the-ocean/>

Smithsonian Museum Oceans: <https://ocean.si.edu/museum>

Cancun Underwater Museum: <https://musamexico.org/>

## References

Mayesky, M. (2011). *Creative activities for young children*. Nelson Education.

National Research Council 2012. *A Framework for K-12 Science Education: Practices, Crosscutting Concepts, and Core Ideas*. Washington, DC: The National Academies Press. <https://doi.org/10.17226/13165>.

Worth, K., & Grollman, S. (2003). *Worms, shadows, and whirlpools: Science in the early childhood classroom*. Portsmouth, NH: Heinemann.



## Scenario 15: Our Animal Friends

**Description:** Feed shelter animals

**Theme:** Environmental protection

**Grade Level:** K-3

**Duration:** 30 – 45 Minutes

### Real-Life Scenario Setting

Smart City volunteers need help! The two animal shelters for dogs and cats are having trouble finding volunteers to feed and take care of the animals. There is a need for an efficient way of feeding these animals without too many volunteers the task requires.

### Task

Your task is to design and operate robotic animal feeding devices to keep furry friends fed and happy.

### Prerequisite Skills

Ability to use the simulation environment.

### STEAM Learning Outcomes

#### Science

- Recognize that populations live in a variety of habitats and change in those habitats affects the organisms living there.
- Use observations to describe patterns of what plants and animals (including humans) need to survive.
- Discuss and communicate that, animals (including humans) and plants need food, water, and air to survive.

#### Technology

- Use motor/movement module to move and manipulate a variety of devices.
- Code and run an algorithm.

#### Engineering

- Identify a problem and design (a) solution(s) that enhance humans' interactions with their surroundings.
- Generate several possible solutions to a given design problem.

#### Art

- Draw/Paint about shelter animals.
- Dress up as different animals, play dramatic activities about sheltered/adopted animals.

#### Mathematics:

- Describe measurable attributes of objects, such as length or weight.
- Represent and solve problems involving addition and subtraction.

- Add and subtract within 20.

### Activity Process

- Watch out for the alerts about automated feeding stations put out.
- Send robots from feeding station to fill up automated feeding machines.
- Fill up the automated feeding machines with the correct amount of food.
- Recall the robots to the filling station to refill food.
- Sustain feeding activity for 5/10/15 minutes without running out of food.

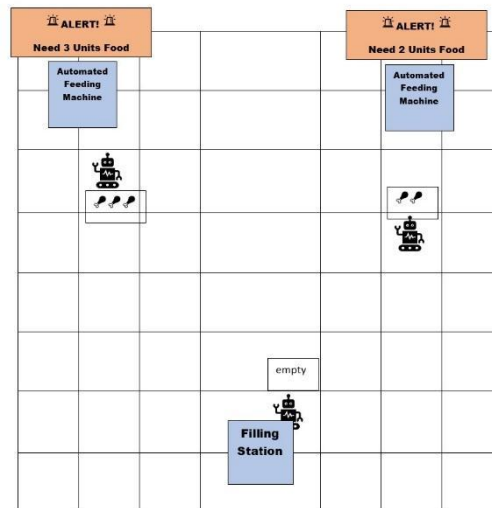

Sample Map

### Assessment

Teachers can bring the experience to real-life classrooms by organizing field trips to animal shelters. Alternatively, many local animal shelters have programs that they visit schools with animals to raise awareness.

The following question can be considered for formative assessment purposes:

- What are the ways plants and animals meet their needs so that they can survive and grow?
- How can we make sure that stray pets are happy and fed?
- Why do some animals have to live in shelters?
- What would you do if you run an animal shelter?

### Career Connections

City and Regional Planning, Software Engineering, Environmental Engineering

### Materials

The simulation environment, the buzzer module, led modules

### Related Resources

PETA (People for Ethical Treatment of Animals) – Animal shelters:  
<https://www.peta.org/issues/animal-companion-issues/animal-shelters/>

RSPCA (Royal Society for the Prevention of Cruelty to Animals) – Education:  
<https://education.rspca.org.uk/>

## **References**

Hendrick, J. (1998). *Total learning: Developmental curriculum for the young child*. Prentice-Hall.

National Research Council (2012). *A Framework for K-12 Science Education: Practices, Crosscutting Concepts, and Core Ideas*. Washington, DC: The National Academies Press. <https://doi.org/10.17226/13165>.

## Scenario 16: Wonder Gardens

**Description:** Efficiently growing variety of organic plants

**Theme:** Sustainability

**Grade Level:** K-4

**Duration:** 45 – 60 Minutes

### Real-Life Scenario Setting

Smart City Parks and Recreation Office has started the Wonder Gardens Project to promote community gardens all around the city. Community gardens not only “improve community health through better nutrition and increased physical activity” but also “help with climate change by reducing the distance food travels and minimize the carbon footprint of food” (SSSA).

### Task

Your team was given an area with three different soil types to grow different fruits and vegetables. These soil types are:

*Sandy soil:* Best for growing carrots. Needs a lot of water.

*Clay Soil:* Best for growing Brussel sprouts. Needs less water.

*Peaty Soil:* Best for growing blueberries. Needs a regular amount of water.

Your task is to design and operate robotic gardening applications to increase efficiency in planting and harvesting fruits and vegetables in the community garden.

### Prerequisite Skills

Ability to use the simulation environment.

### STEAM Learning Outcomes

#### Science

- Predict and infer from observations.
- Use observations to describe patterns of what plants and animals (including humans) need to survive.
- Use instruments to measure length, temperature, volume, and weight using appropriate units.
- Predict the effects of changes in the environment (e.g., temperature, light, moisture) on a living organism
- Explore ways to conserve water.

#### Technology

- Use motor/movement module to move and manipulate a variety of devices.
- Code and run an algorithm.

## Engineering

- Identify a problem and design (a) solution(s) that enhance humans' interactions with their surroundings.
- Generate several possible solutions to a given design problem.

## Art

- Build skills in various media and approaches to art-making; use art materials, tools, and equipment safely; and create art that communicates a story about a natural or constructed environment.
- Create unique decorations for your gardening robots.

## Mathematics:

- Describe measurable attributes of objects, such as length or weight.
- Represent and solve problems involving addition and subtraction.
- Solve multi-step word problems posed with whole numbers and having whole-number answers using the four operations, including problems in which remainders must be interpreted

## Activity Process

- Select appropriate seeds for the soil type.
- Send gardening robots to plant seeds.
- Monitor the humidity probes for water levels.
- Send gardening robots to water the plants.
- Maintain the community garden until plants are fully grown.

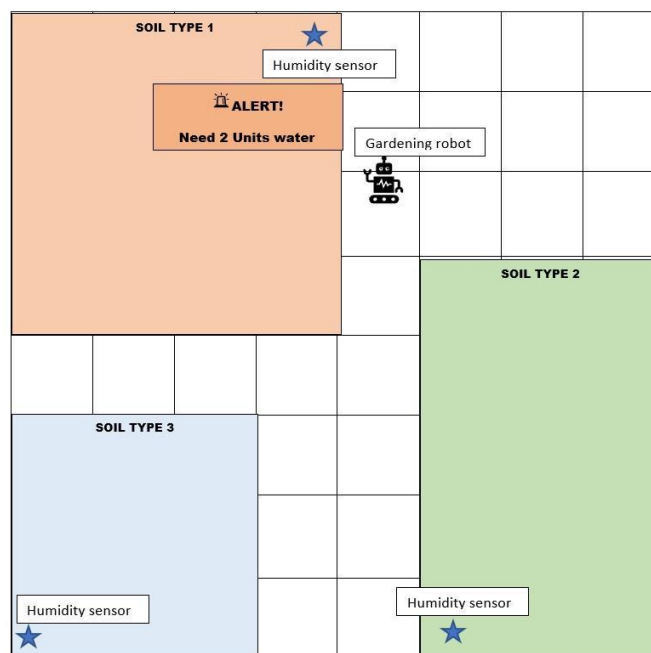

Sample Map

## Assessment

Teachers can make the students experience to real-life problems by bringing different soil types in containers and letting students touch the soil samples. Teachers can demonstrate

different soil types by putting an equal amount of soil samples in different jars, adding water, shaking the jar, and letting water separate different materials in the soil.

The following question can be considered for formative assessment purposes:

- What are some ways plants and animals meet their needs so that they can survive and grow?
- How can we make plants grow and conserve water at the same time?
- Which plants and vegetables would you grow if you had a garden?

### **Career Connections**

City and Regional Planning, Software Engineering, Environmental Engineering.

### **Materials**

The simulation environment, humidity module, buzzer module, led module

### **Related Resources**

SSSA (Soil science society of America) – Community Gardens:  
<https://www.soils.org/about-soils/community-gardens/>

PBS – In the Garden with Bryce Lane:  
<https://www.pbsnc.org/watch/unctv-originals/in-the-garden-with-bryce-lane/>

### **References**

- Egli, V., Oliver, M., & Tautolo, E. S. (2016). *The development of a model of community garden benefits to well-being*. Preventive medicine reports, 3, 348-352.
- Grard, B., Bel, N., Marchal, N., Madre, N., Castell, J. F., Cambier, P., ... & Aubry, C. (2015). Recycling urban waste as possible use for rooftop vegetable garden. *Future of Food: Journal on Food, Agriculture and Society*, 3(1), 21-34.
- National Research Council 2012. *A Framework for K-12 Science Education: Practices, Crosscutting Concepts, and Core Ideas*. Washington, DC: The National Academies Press. <https://doi.org/10.17226/13165>.



## Theme – Covid-19 Pandemic

Faced with the global COVID-19 pandemic, declared by the World Health Organization (WHO) in 2020. March 11, and the need for a better understanding of the seasonal behaviour of the virus and the conditions for limiting its spread. Thus, for STEM professionals, the convergence of many STEM disciplines is essential in searching for solutions, such as the development of COVID-19 vaccines and cures. Similarly, for K-12 students, a convergence of several STEM subjects should become necessary to make informed decisions and take responsible actions both in personal areas (e.g., wearing masks and washing hands thoroughly and frequently) and in social areas (e.g., maintaining social distance and stay at home) [1].

Respiratory droplets are thought to be the main route of transmission of SARS CoV infection. However, the virus can also be found in other body fluids and excreta. The stability of the virus depends on the temperature and humidity of the smooth surface [2]. Thus, contact with contaminated surfaces can also play an important role [3]. At room temperature (24 ° C), the half-life of the virus ranged from 6.3 to 18.6 hours, depending on relative humidity, but decreased to 1.0-8.9 hours when the temperature was raised to 35 ° C.

In order to curb the epidemic, not only scientists but also society must work diligently. There are a number of recommended actions society can take. The main ways to prevent the spread of COVID-19 is often referred to as “Three C’s” (Fig. 1.):

- Crowded places;
- Close-contact settings, especially where people have conversations very near each other;
- Confined and enclosed spaces with poor ventilation.

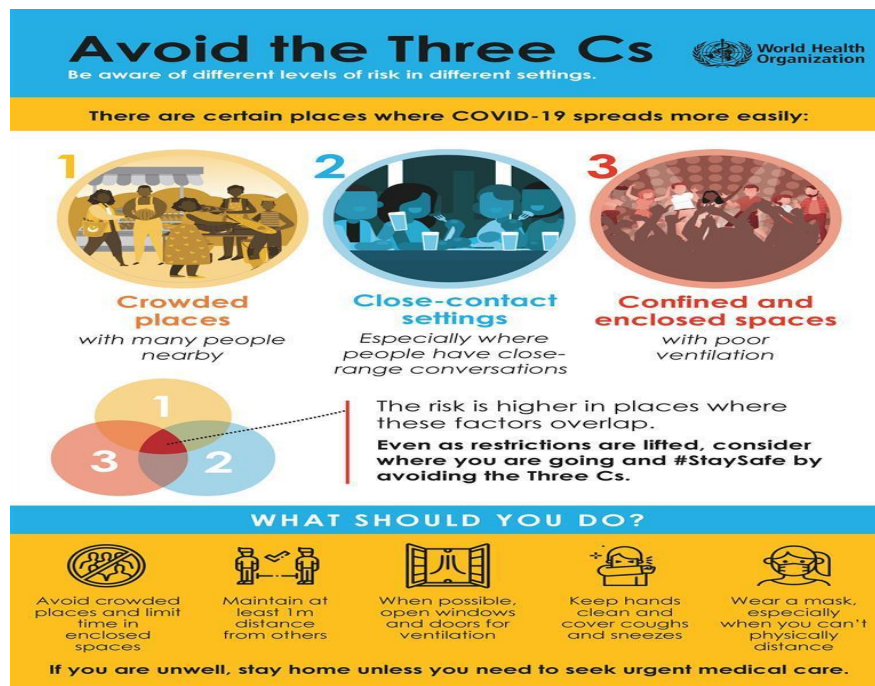

Fig. 1 The Three C's [4]

Physical distancing helps limit the spread of COVID-19 – this means we keep a distance of at least 1-2 m from each other and avoid spending time (at least for a total of 15 minutes) in crowded places or groups [5].

Cleaning with a household cleaner containing soap or detergent reduces the number of germs on surfaces and reduces the risk of infection from surfaces. In most cases, cleaning alone removes most virus particles from surfaces. When using any disinfectant, it is important to ensure adequate ventilation by keeping doors and windows open and using fans to improve airflow [6]. Clean outdoor air is needed to improve ventilation and prevent the accumulation of virus particles inside. If safe to do so, open doors and windows as much as you can to breathe fresh outdoor air [7]. The normal outdoor air level is 250-350 parts per million (ppm) carbon dioxide in the atmosphere. And typical level found in occupied spaces with good air exchange - 350-1,000 ppm [8].

Although the prevalence of COVID-19 appears to be lower in warm and humid climates, temperature and relative humidity alone do not explain the variability of most COVID-19 outbreaks. Policies of social isolation, herd immunity, migration patterns, population density and cultural aspects can have a direct impact on the spread of this disease [9]. With that in mind, we can help prevent health problems.

## References

1. Lee, O., & Campbell, T. (2020). What science and STEM teachers can learn from COVID-19: Harnessing data science and computer science through the convergence of multiple STEM subjects. *Journal of Science Teacher Education*, 31(8), 932-944. OMEGA Engineering. (2021). *Accelerometer: Introduction to Accelerometers*. <https://www.omega.co.uk/prodinfo/accelerometers.html>.
2. Chan, K. H., Peiris, J. M., Lam, S. Y., Poon, L. L. M., Yuen, K. Y., & Seto, W. H. (2011). The effects of temperature and relative humidity on the viability of the SARS coronavirus. *Advances in virology*, 2011.
3. Biryukov, J., Boydston, J. A., Dunning, R. A., Yeager, J. J., Wood, S., Reese, A. L., ... & Altamura, L. A. (2020). Increasing temperature and relative humidity accelerates inactivation of SARS-CoV-2 on surfaces. *MSphere*, 5(4), e00441-20.
4. World Health organization. (2020). *Coronavirus disease (COVID-19): How is it transmitted?* <https://www.who.int/news-room/q-a-detail/coronavirus-disease-covid-19-how-is-it-transmitted>
5. National Center for Immunization and Respiratory Diseases (NCIRD), Division of Viral Diseases. (2021). *Contact Tracing for COVID-19*. <https://www.cdc.gov/coronavirus/2019-ncov/php/contact-tracing/contact-tracing-plan/contact-tracing.html>
6. National Center for Immunization and Respiratory Diseases (NCIRD), Division of Viral Diseases. (2021). *Cleaning and Disinfecting Your Home*. <https://www.cdc.gov/coronavirus/2019-ncov/prevent-getting-sick/disinfecting-your-home.html>
7. National Center for Immunization and Respiratory Diseases (NCIRD), Division of Viral Diseases. (2021). *Improving Ventilation in Your Home*. <https://www.cdc.gov/coronavirus/2019-ncov/prevent-getting-sick/Improving-Ventilation-Home.html>
8. Bonino, S. (2016). Carbon Dioxide Detection and Indoor Air Quality Control. *Occupational health & safety (Waco, Tex.)*, 85(4), 46-48.
9. Mecenas, P., Bastos, R. T. D. R. M., Vallinoto, A. C. R., & Normando, D. (2020). Effects of temperature and humidity on the spread of COVID-19: A systematic review. *PLoS one*, 15(9), e0238339.



## Scenario 17: Touch-Free Hand Sanitizer

**Description:** Create a touch-free hand sanitizer that automatically dispenses sanitizer

**Theme:** Covid-19 pandemic

**Grade Level:** Middle Schools / Junior High Schools (Ages 10 to 14)

**Duration:** 2 class hours

Disinfecting kills any remaining germs on surfaces and reduces the spread of germs.

### Real-Life Scenario Setting

Disinfection destroys the remaining germs on the surfaces and reduces the spread of microbes. However, during a coronavirus 19 (COVID-19) pandemic, it is especially important to keep your hands clean to prevent the virus from spreading. Clean hands can stop the spread of microbes from one person to another and throughout the community, from your home and workplace to childcare facilities and hospitals [10].

In order to reduce the virus spreading the hand sanitizer can be used. The smart sanitizer is a touch-free dispenser that detects hand motions to dispense its contents. Using an ultrasonic sensor, it is possible to dispense sanitizer on the hands without pressing the bottle trigger. The servo motor mounted on the hand sanitizer bottle will do it instead of you. The servo motor will press the trigger only when the distance is less than or equal to 5 cm.

### Task

Your team will design a smart touch-free hand sanitizer device that:

- detects hand motions to dispense its contents;
- give an alarm or notification after dispensing.

### Technical Information

The **ultrasonic sensor HC SR-04** consists of Transmitter and Receiver modules. The transmitter part ejects the pulse out, and the receiver part receives the pulse. The basic principle of ultrasonic distance measurement is based on ECHO. When sound waves are transmitted in the environment, then waves are returned back to the origin as ECHO after striking on the obstacle. So, we only need to calculate the traveling time of both sounds means outgoing time and returning time to origin after striking on the obstacle. As the speed of the sound is known to us, after some calculation, we can find the distance.

When we place our hand in front of the distance sensor, it will help the Arduino to measure the distance (if it is less than or equal to 5 cm) from the sensor to the hand.

More:

<https://electronicsprojectshub.com/distance-measurement-using-arduino-ultrasonic-sensor/>

### Prerequisite Skills

Basic use of sensors and basic coding skills

## STEAM Learning Outcomes

### Science

- Explain the importance of keeping hands clean during the pandemic
- Explain the concept of sensor
- Explain the term of distance

### Technology

- Use distance sensor
- Use buzzer and LED's
- Create and run an algorithm

### Engineering

- Use engineering design processes to create a smart distance measuring system that will detect hand motion at a proper distance.

### Arts

- Develop awareness of the importance of hand hygiene in healthcare settings.
- Explain how to use hand sanitizer.
- Explain the effect of pandemics on the environment, public health, and economy.

### Mathematics

- Explain how to measure the distance.
- Explain the types of units for measuring length.

## Activity Process

Teachers are recommended to follow the following steps:

- Encourage students to read the task statement and brainstorm about possible solutions. Questions to consider for probing students' thoughts can be:
  - Have you ever seen the automated hand sanitizers at school, at a hospital, at a supermarket? What can be the reason for its use? What kind of problems can we avoid by using a touch-free hand sanitizer?
  - How can we detect the hand?
  - How can we develop an algorithm to detect and notify when the hand is under sanitizer?
- Guide students to write an algorithm that measures distance and gives notification when it is proper (e.g., play a sound, show a text, or turn on a LED).
- This activity is a suitable one to talk about loop structures in algorithms. Please discuss this issue with the students if necessary.
- Make students share their solution strategies.

## Assessment

The following questions can be considered for formative assessment purposes.

- Is it essential to avoid touching objects during the pandemic? Why? Or why not?
- How can you measure the distance between two objects?
- How to detect the hand motion?
- What criteria would you use for a warning system? Explain your reasoning in detail.

The following are expected from students:

- Develop a touch-free hand sanitizer system.
- Share their team's device with others effectively and clearly, explaining their reasoning in their choices.

### **Career Connections**

Electric and Electronic Engineering, Environmental Engineering, Chemistry Engineering

### **Materials**

The simulation environment and Arduino kit with sensor or alternative distance measure or movement detection sensors

### **Related Readings**

COVID - 19 Automatic Hand Sanitizer (using ultrasonic sensor).

<https://create.arduino.cc/projecthub/akshayjoseph666/covid-19-automatic-hand-sanitizer-78cf6b>

Automatic Hand Sanitizer (using infrared obstacle avoidance sensor).

<https://create.arduino.cc/projecthub/Nikolas550/automatic-hand-sanitizer-c22fcc>

Distance Measurement Using Arduino Ultrasonic Sensor.

<https://create.arduino.cc/projecthub/Junezriyaz/distance-measurement-using-arduino-ultrasonic-sensor-409169>

National Center for Immunization and Respiratory Diseases (NCIRD), Division of Viral Diseases. (2019). *Hand Hygiene in Healthcare Settings*.

<https://www.cdc.gov/handhygiene/index.html>

### **References**

[10] National Center for Immunization and Respiratory Diseases (NCIRD), Division of Viral Diseases. (2021). *When and How to Wash Your Hands*.

<https://www.cdc.gov/handwashing/when-how-handwashing.html>

## Scenario 18: Detecting the Distance

**Description:** Design the distance detecting system that will give a warning (light and sound) if the distance is critical (less than 1 meter)

**Theme:** Covid-19 pandemic

**Grade Level:** Middle Schools / Junior High Schools (Ages 10 to 14)

**Duration:** 2 class hours

### Real-Life Scenario Setting

The practice of social distancing means staying at home and staying away from others as much as possible to avoid the spread of COVID-19. As communities reopen and people become more public, the term “physical distancing” (instead of social) is used. Physical distancing helps to limit the spread of COVID-19, which means that we keep a distance of at least 1-2 m from each other and avoid spending time (at least 15 minutes in total) in crowded places or groups [5]. The challenge is to avoid crowded places, especially indoors, and events that can attract crowds, as well as to keep a strict distance of at least 1-2 meters between yourself and others. Most public places use social distance marking for other common areas, such as toilets, showers, lockers, and changing rooms, and in all other places where queues usually form.

In order to improve customers’ queuing physical distance marking system, a smart warning system can be used. The system could warn you if the distance is too short. Using Ultrasonic Sensor HC SR-04 it is possible to measure the distance precisely. The sensor data is also displayed on an LCD monitor.

### Task

Your team will design a smart distance monitoring device that:

- to determine the distance of an obstacle from the sensor;
- display the output each 1 minute;
- give an alarm or notification if the distance is too short.

### Technical Information

The ultrasonic sensor HC SR-04 consists of Transmitter and Receiver modules. The transmitter part ejects the pulse out, and the receiver part receives the pulse. The basic principle of ultrasonic distance measurement is based on ECHO. When sound waves are transmitted in the environment, then waves are returned back to the origin as ECHO after striking on the obstacle. So, we only need to calculate the traveling time of both sounds means outgoing time and returning time to origin after striking on the obstacle. As the speed of the sound is known to us, after some calculation, we can find the distance.

More:

<https://electronicsprojectshub.com/distance-measurement-using-arduino-ultrasonic-sensor/>

### Prerequisite Skills

Basic use of sensors and basic coding skills

## STEAM Learning Outcomes

### Science

- Explain the importance of adequate ventilation assurance while using any disinfectant indoor
- Explain the concept of sensor
- Explain the term of distance
- Explain the difference of terms: social distance and physical distance

### Technology

- Use distance sensor
- Use LCD monitor
- Use buzzer and LED's
- Create and run an algorithm

### Engineering

- Use engineering design processes to create a smart distance measuring system that will monitor the physical distance.

### Arts

- Develop awareness of the importance of social distance.
- Explain the main social distancing practices.
- Explain the effect of pandemics on the environment, public health, and economy.

### Mathematics

- Explain how to measure the distance.
- Explain the types of units for measuring length.

## Activity Process

Teachers are recommended to follow the following steps:

- Encourage students to read the task statement and brainstorm about possible solutions. Questions to consider for probing students' thoughts can be:
  - Have you ever seen the social distance marking areas at home, school, hospital, and supermarket? What can be the reason for its use? What kind of problems can we avoid by following the marking systems?
  - How can we show the proper distance?
  - How can we develop an algorithm to detect and notify when the distance is too short?
- Guide students to write an algorithm that measures distance and gives notifications when too short (e.g., play a sound, show a text, or turn on a LED).
- This activity is a suitable one to talk about loop structures in algorithms. Please discuss this issue with the students if necessary.
- Make students share their solution strategies.

## Assessment

The following questions can be considered for formative assessment purposes.

- Is it essential to monitor the distance between persons during the pandemic? Why? Or why not?
- How can you measure the distance between two objects?



- What criteria would you use for a warning system? Explain your reasoning in detail.

The following are expected from students:

- Develop the distance measurement system.
- Share their team's device with others effectively and clearly, explaining their reasoning in their choices.

### **Career Connections**

Electric and Electronic Engineering, Environmental Engineering, Chemistry Engineering

### **Materials**

The simulation environment and Arduino kit with sensor or alternative distance measure sensors

### **Related Readings**

Distance Measurement Using Arduino Ultrasonic Sensor.

<https://create.arduino.cc/projecthub/lunezriyaz/distance-measurement-using-arduino-ultrasonic-sensor-409169>

National Center for Immunization and Respiratory Diseases (NCIRD), Division of Viral Diseases. (2021). Public Health Guidance for Community-Related Exposure.

<https://www.cdc.gov/coronavirus/2019-ncov/php/public-health-recommendations.html>

### **References**

[5] National Center for Immunization and Respiratory Diseases (NCIRD), Division of Viral Diseases. (2021). *Contact Tracing for COVID-19*.

<https://www.cdc.gov/coronavirus/2019-ncov/php/contact-tracing/contact-tracing-plan/contact-tracing.html>

## Scenario 19: Monitoring the Air Condition

**Description:** Design gas level detecting in room air system that will give a warning when the level is critical (more than 1000 ppm) and also will show the gas level on LCD each 15 minutes

**Theme:** Covid-19 pandemic

**Grade Level:** Middle Schools / Junior High Schools (Ages 10 to 14)

**Duration:** 2 class hours

### Real-Life Scenario Setting

Respiratory droplets are thought to be the main route of transmission of SARS CoV infection. However, the virus can also be found in other body fluids and excreta. Thus, cleaning with a household cleaner containing soap or detergent reduces the amount of microbes on surfaces and reduces the risk of infection from surfaces. In most cases, cleaning alone removes most virus particles from surfaces. When using any disinfectant, it is important to ensure adequate ventilation by keeping doors and windows open and using fans to improve airflow [6].

Clean outdoor air is needed to improve ventilation and prevent the accumulation of virus particles inside. If safe to do so, open doors and windows as much as you can to breathe fresh outdoor air [7]. The normal outdoor air level is 250-350 parts per million (ppm) of gas in the atmosphere. And typical level found in occupied spaces with good air exchange - 350-1,000 ppm [8]. Using an MQ-135 gas sensor, it is possible to know and monitor air pollution. The sensor data is also displayed on an LCD monitor.

### Task

Your team will design a smart air pollution monitoring device that:

- measures and monitors ppm of gas in the air in real-time, tell the quality of air;
- display the output every 15 minutes;
- give an alarm or notification if the gas level is too high

### Technical Information

The MQ-135 Gas sensor can detect gases like Ammonia (NH<sub>3</sub>), sulphur (S), Benzene (C<sub>6</sub>H<sub>6</sub>), CO<sub>2</sub>, and other harmful gases and smoke. Similar to other MQ series gas sensors, this sensor also has a digital and analog output pin. When the level of these gases goes beyond a threshold limit in the air, the digital pin goes high. This threshold value can be set by using the onboard potentiometer. The analog output pin outputs an analog voltage that can be used to approximate the level of these gases in the air. The MQ135 air quality sensor module operates at 5V and consumes around 150mA. It requires some pre-heating before it can actually give accurate results.

The analog output voltage from the sensor can be assumed directly proportional to the concentration of CO<sub>2</sub> gas in PPM under standard conditions. The analog voltage is sensed from the sensor and converted to a digital value ranging from 0 to 1023 by the inbuilt ADC channel of the controller. The digitized value is hence equal to the gas concentration in PPM.

More: <https://quartzcomponents.com/products/mq-135-air-quality-gas-sensor-module>

## Prerequisite Skills

Basic use of sensors and basic coding skills

## STEAM Learning Outcomes

### Science

- Explain the importance of adequate ventilation assurance while using any disinfectant indoor
- Explain the concept of sensor
- Explain the terms of air pollution and ppm

### Technology

- Use relative gas sensor
- Use LCD monitor
- Use buzzer and LED's
- Create and run an algorithm

### Engineering

- Use engineering design processes to create a smart gas level detecting in room air system that will monitor the environment condition.

### Arts

- Develop awareness of the importance of carbon dioxide and gas detection and indoor air quality control.
- Explain the main virus amount decrease on surfaces methods and health security rules.
- Explain the effect of pandemics on the environment, public health, and economy.

### Mathematics

- Describe how to convert the gas sensor data to gas concentration in PPM.
- Explain how to measure gas levels in the air.

## Activity Process

Teachers are recommended to follow the following steps:

- Encourage students to read the task statement and brainstorm about possible solutions. Questions to consider for probing students' thoughts can be:
  - Have you ever seen the gas measuring devices at home, school, hospital, or SPA? What can be the reasons for its use? What kind of problems can we avoid by knowing the gas level in the air?
  - How can we detect the gas of air?
  - How can we develop an algorithm to detect and notify when the gas level in the air is too high?
- Guide students to write an algorithm that measures gas ppm and gives notification when it is too high (e.g., play a sound, show a text, or turn on a LED).
- This activity is a suitable one to talk about loop structures in algorithms. Please discuss this issue with the students if necessary.
- Make students share their solution strategies.

## Assessment

The following questions can be considered for formative assessment purposes.

- Is it essential to monitor the gas level in the room air? Why? Or why not?
- How can you measure the concentration of gas in the environment?
- What criteria would you use for a warning system? Explain your reasoning in detail.

The following are expected from students:

- Develop the gas level measure system.
- Share their team's device with others effectively and clearly, explaining their reasoning in their choices.

### **Career Connections**

Electric and Electronic Engineering, Environmental Engineering, Chemistry Engineering

### **Materials**

The simulation environment and Arduino kit with a sensor or alternative gas sensors

### **Related Readings**

Carbon Dioxide Detection and Indoor Air Quality Control. (2016).

<https://ohsonline.com/Articles/2016/04/01/Carbon-Dioxide-Detection-and-Indoor-Air-Quality-Control.aspx?Page=1>

### **References**

- [6] National Center for Immunization and Respiratory Diseases (NCIRD), Division of Viral Diseases. (2021). *Cleaning and Disinfecting Your Home*.  
<https://www.cdc.gov/coronavirus/2019-ncov/prevent-getting-sick/disinfecting-your-home.html>
- [7] National Center for Immunization and Respiratory Diseases (NCIRD), Division of Viral Diseases. (2021). *Improving Ventilation in Your Home*.  
<https://www.cdc.gov/coronavirus/2019-ncov/prevent-getting-sick/Improving-Ventilation-Home.html>
- [8] Bonino, S. (2016). Carbon Dioxide Detection and Indoor Air Quality Control. *Occupational health & safety (Waco, Tex.)*, 85(4), 46-48.

## Scenario 20: Monitoring the Temperature and Humidity of the Room

**Description:** Design the temperature and relative humidity level measuring device that will give a warning when the level is too low and also will show it on LCD each 30 minutes

**Theme:** Covid-19 Pandemic

**Grade Level:** Middle Schools / Junior High Schools (Ages 10 to 14)

**Duration:** 2 class hours

### Real-Life Scenario Setting

Respiratory droplets are thought to be the major route of transmission of SARS CoV infection. However, the virus can also be found in other body fluids and excreta. The researchers studied the stability of the virus at different temperatures and relative humidity on smooth surfaces. Improved stability of SARS coronavirus at low temperatures and low humidity in the environment may facilitate its transmission in the community [2].

Previous studies have reported the stability of SARS-CoV-2 in cell culture medium and deposition on surfaces under limited environmental conditions such as relative humidity, temperature, and droplet size. The results show that with increasing humidity or temperature, SARS-CoV-2 degrades faster, and the surface type (stainless steel, plastic, or nitrile gloves) does not significantly affect the degradation rate. At room temperature (24 ° C), the half-life of the virus ranged from 6.3 to 18.6 hours, depending on relative humidity, but was reduced to 1.0 to 8.9 hours when the temperature was raised to 35 ° C. [3].

In order to reduce the virus half-life range, the scientists suggest increasing the room temperature at least to 35°C and relative humidity at least to 80%. Using the DHT-22 relative humidity and temperature sensor and an LCD monitor, it is possible to know and monitor the temperature and humidity of the environment.

### Task

Your team will design a smart relative humidity and temperature measurement device that:

- measure relative humidity and temperature;
- display the output every 30 minutes;
- give an alarm or notification if the level is too low

### Technical Information

The DHT-11 is a digital output, relative humidity, and temperature sensor. It uses a capacitive humidity sensor and a thermistor to measure the surrounding air and sends a digital signal on the data pin.

More: <https://create.arduino.cc/projecthub/projects/tags/humidity>

### Prerequisite Skills

Basic use of sensors and basic coding skills

## STEAM Learning Outcomes

### Science

- Explain the importance of proper air condition for virus stability decrease
- Explain the concept of sensor
- Explain the terms of temperature, and relative humidity

### Technology

- Use relative humidity and temperature sensor
- Use LCD monitor
- Use buzzer and LED's
- Create and run an algorithm

### Engineering

- Use engineering design processes to create a smart relative humidity and temperature level measurement device to monitor the environment condition.

### Arts

- Develop awareness of the importance of virus transmission settings.
- Explain the main routes of virus transmission.
- Explain the effect of the pandemic on the environment, public health, and economy.

### Mathematics

- Describe how to convert the humidity and temperature analog sensor data to percentage and temperature (more: <https://www.circuitbasics.com/arduino-thermistor-temperature-sensor-tutorial> ; <https://www.circuitbasics.com/how-to-set-up-the-dht11-humidity-sensor-on-an-arduino/> )
- Explain how to measure relative humidity.
- Describe how to convert Celsius to Fahrenheit.

## Activity Process

Teachers are recommended to follow the following steps:

- Encourage students to read the task statement and brainstorm about possible solutions. Questions to consider for probing students' thoughts can be:
  - Have you ever seen the temperature and humidity measurement devices at home, school, hospital, or SPA? What can be the reasons for its use? What kind of problems can we avoid by knowing the temperature and humidity of our environment?
  - How can we detect the temperature of air?
  - How can we detect the humidity of air?
  - How can we develop an algorithm to detect and notify when the temperature and humidity are too low?
- Guide students to write an algorithm that measures temperature and relative humidity and gives notification when it is too low (e.g., play a sound, show a text, or turn on a LED).
- This activity is a suitable one to talk about loop structures in algorithms. Please discuss this issue with the students if necessary.
- Make students share their solution strategies.

## Assessment

The following questions can be considered for formative assessment purposes.

- Is it essential to monitor the temperature and humidity of room air? Why? Or why not?
- How can you measure the temperature and humidity of room air?
- What criteria would you use for a warning system? Explain your reasoning in detail.

The following are expected from students:

- Develop the temperature and humidity measurement system.
- Share their team's device with others effectively and clearly, explaining their reasoning in their choices.

## Career Connections

Electric and Electronic Engineering, Environmental Engineering, Chemistry Engineering

## Materials

The simulation environment and Arduino kit with a sensor or alternative humidity and temperature sensors

## Related Readings

33 humidity projects with Arduino.

<https://create.arduino.cc/projecthub/projects/tags/humidity>

Make an Arduino temperature sensor (thermistor tutorial).

<https://www.circuitbasics.com/arduino-thermistor-temperature-sensor-tutorial>

How to set up the dht11 humidity sensor on an Arduino.

<https://www.circuitbasics.com/how-to-set-up-the-dht11-humidity-sensor-on-an-arduino/>

## References

- [2] Chan, K. H., Peiris, J. M., Lam, S. Y., Poon, L. L. M., Yuen, K. Y., & Seto, W. H. (2011). The effects of temperature and relative humidity on the viability of the SARS coronavirus. *Advances in virology*, 2011.
- [3] Biryukov, J., Boydston, J. A., Dunning, R. A., Yeager, J. J., Wood, S., Reese, A. L., ... & Altamura, L. A. (2020). Increasing temperature and relative humidity accelerates inactivation of SARS-CoV-2 on surfaces. *MSphere*, 5(4), e00441-20.

## Theme - Mobility in a Smart City

According to the United Nations, in July 2007, the urban population surpassed the rural population of the world. Furthermore, this proportion is expected to increase dramatically in the coming years, to the point that, by 2050, almost 70% of the world's population will be urban, and many cities will have more than 10 million inhabitants. It is estimated that by 2025 in China alone, there will be 221 cities with more than 10 million inhabitants. Europe currently has 35 of these cities.

Cities have a huge impact on the economic and social development of countries around the world. Nowadays, cities are platforms where people live, and companies have their businesses.

As a natural consequence of this, cities have associated an extensive set of services available to citizens. Currently, cities consume 75% of energy resources and generate 80% of toxic gases for the ozone layer, considering they occupy only 2% of the world's territory.

Planet Earth is becoming more and more urban, taking into account this premise, cities need to be formatted to adapt to new realities and, with the help of technology, to become smarter. To deal with this ever-increasing urbanization, there is a need to find new ways to manage the complexity inherent to new realities, increase efficiency, and reduce expenses, thus give a better quality of life to people living in the large urban centers.



## Scenario 21: Vehicle detection on a road

**Description:** Design a device that calculates the number of vehicles on the road.

**Theme:** Count of vehicles traveling in a smart city

**Grade Level:** Middle Schools / Junior High Schools (Ages 10 to 14)

**Duration:** 2 hours of class

### Real-Life Scenario Setting

One of the existing problems when studying the issue of traffic in large cities is the lack of information about the volume of traffic. In some countries, such as the United States, this type of information is commonly available on the websites of state and city traffic departments. An example can be found on the Florida Department of Transportation website (<http://www.dot.state.fl.us/>). This lack of information ends up making it difficult, among other things, for the most effective actions to control traffic to be taken to minimize its negative impacts. So if a city understands the flow of traffic that exists, it allows officials to better manage the flow of traffic, directing traffic to other less-used roads and thus reducing the stress level of people who are using transport.

### Task

Suppose you are a team member in the DRDI office and are responsible for transforming your city into a smart city with a new traffic flow management project. Your team will have several tasks regarding the intelligent traffic flow in the city, developing a traffic flow management plan, and implementing a vehicle counting solution in the robotics simulation program.

In this activity, the task of each team is:

- Observe the traffic flow on the streets given in the simulation environment.
- Determine the most inappropriate transit zones using the following sensors: ultrasonic and infrared.
- Report traffic flow levels in the most critical areas of a city.
- Prepare a report and present it to the other DRDI teams.

### Technical information

The measure found to solve the problem of the difficulties was to use the infrared sensor. This sensor allows detecting vehicles in areas with a radius of action (length) is smaller. As it performs a cone-shaped reading, the ultrasonic sensor is used to count vehicles in areas whose radius of action is larger. Figure 1 shows this idea:

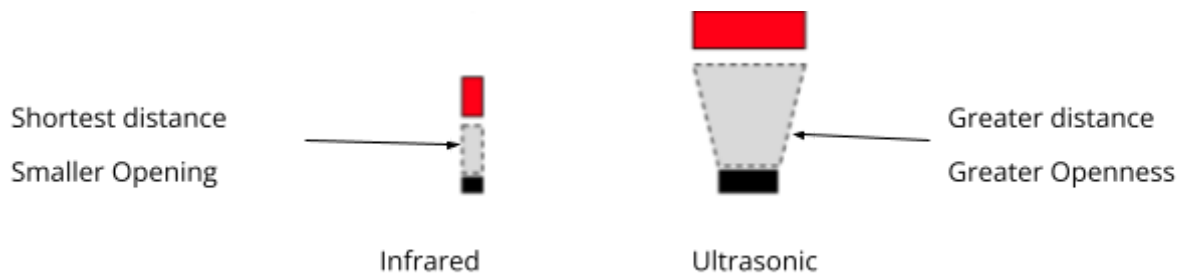

The **infrared sensor** has better accuracy for being more directional; however, its distance is more limited since the detection of obstacles reaches only  $80\text{cm}$ .

The **ultrasonic sensor**, in turn, has a greater range, reaching to detect obstacles with a distance of  $3\text{m}$ . Despite this, the waves emitted for the detection of obstacles expand into a conical shape, making the detected obstacles not only those in front of the sensor but also at an approximate angle of  $45^\circ$  to the left or right.

As you can see, designing or investigating meters of various types of vehicles is complex, and there is a need to adapt the system with different sensors taking into account the size of the vehicles.

### Prerequisite Skills

Investigate the conditions which would be the ideal traffic for a city to be environmentally sustainable.

### STEAM Learning Outcomes

#### Science

- Use sensors to explain the traffic levels that exist in a city (numerical values).
- Determine the pollution generated by this traffic.

#### Technology

- Use an infrared sensor
- Use an ultrasonic sensor
- Create flowcharts in the Execute sandbox
- An algorithm

#### Engineering

- Make designs for the vehicle counter to be applied to a pole.

#### Art

- Gain awareness about the pollution that is generated in a city by vehicles.
- Gain environmental awareness.

#### Math

- Use ratios and proportions
- Solve problems related to angles

## Activity Process

Teachers are recommended to take the following steps:

- Encourage students to carefully read the task statement and brainstorm street conditions in their neighborhood.

Ask students:

- Have you ever thought about the number of vehicles that walk on the streets every day?
- What are the factors that can affect the sensors (Infrared and Ultrasonic) used in the project?
- Instruct students to set up a sensor that can be used to count the number of vehicles on the street using various places on the map.
- Ask students to use and determine areas with less or more traffic on the map.

## Assessment

The following question can be considered for formative assessment purposes.

- What is the infrared sensor for?
- What is the ultrasonic sensor for?
- What are the measurement units used in each sensor?

The following is expected from students:

- Develop a sensor that can count the number of vehicles walking on the streets of a city, from various points on the map in the simulation environment.
- Write and share a report on the problems found in solving the proposed exercise on the map using appropriate technical terminology.

## Career Connections

Municipal and Regional Planning, Electrical and Electronic Engineering, Earth and Space Sciences, Environmental Engineering

## Materials

The simulation environment includes a street map and sensors: infrared and ultrasonic.

## Related Readings

[1] Bhoi, S.K., Khilar, P.M. A Road Selection Based Routing Protocol for Vehicular Ad Hoc Network. *Wireless Pers Commun* 83, 2463–2483 (2015). <https://doi.org/10.1007/s11277-015-2540-x>

[2] Francesco Deflorio, Paolo Guglielmi, Ivano Pinna, Luca Castello, Sergio Marfull,

Modeling and Analysis of Wireless “Charge While Driving” Operations for Fully Electric Vehicles, Transportation Research Procedia, Volume 5, 2015, Pages 161-174, ISSN 2352-1465, <https://doi.org/10.1016/j.trpro.2015.01.008>.

[3] Zimmerman K, Bonneson JA. Intersection Safety at High-Speed Signalized Intersections: Number of Vehicles in Dilemma Zone as Potential Measure. Transportation Research Record. 2004;1897(1):126-133. doi:10.3141/1897-16

[4] Moeller, M. P., Urbanik, II, T., & Desrosiers, A. E. CLEAR (Calculates Logical Evacuation And Response): A Generic Transportation Network Model for the Calculation of Evacuation Time Estimates. United States. <https://doi.org/10.2172/1080214>

[5] <https://jati.um.edu.my/index.php/MJCS/article/view/2995>

## Scenario 22: Create a smart traffic light

**Description:** Design a standalone traffic light.

**Theme:** Mobility in a Smart City

**Grade Level:** Middle Schools / Junior High Schools (Ages 10 to 14)

**Duration:** 2 hours of class

### Real-Life Scenario Setting

One of the existing problems when studying the issue of traffic in large cities is the lack of information about the volume of traffic. With this objective, the traffic light aims to mitigate some of the traffic volume problems, especially in large cities. Some countries, such as China, are already changing their traditional traffic lights to smart traffic lights. An example can be seen in the city of Shenzhen, intelligent traffic lights managed to reduce traffic congestion by 8% and increase traffic speed by 15%; this is only possible with changes that have been made to the lanes, such as obtaining the number of cars passing on the lanes. The biggest problem is that in big cities, there is a lack of information about the routes, and this ends up making it difficult, among other things, the most effective actions to control traffic are taken to minimize its negative impacts. So if a city understands the flow of traffic that exists, it allows it to better manage the flow of traffic, directing traffic to other less-used roads and thus reducing the stress level of people who are using transport.

Suppose you are a team member in the DRDI office and are responsible for transforming your city into a smart city with a new design for smart transit traffic. Your team will have several tasks related to smart traffic flow and traditional traffic signs in the city, developing a study for the implementation of a smart traffic sign in the robotics simulation program.

### Task

In this activity, the task of each team is:

1. Observe road signs on the streets in the simulation environment.
2. Determine the traffic zones that would be an asset to implement a smart traffic sign.
3. Report traffic flow levels in the most critical areas of a city where there are no road signs and implement a report to implement smart road signs.
4. Prepare a report and present it to the other DRDI teams.

### Technical information

The measure found to solve the problem of the difficulties encountered in assembling traffic lights is seen in the following figure. This project is linked to the previous scenario, aiming to connect sensors, ultrasonic and infrared, to this traffic lights scenario.

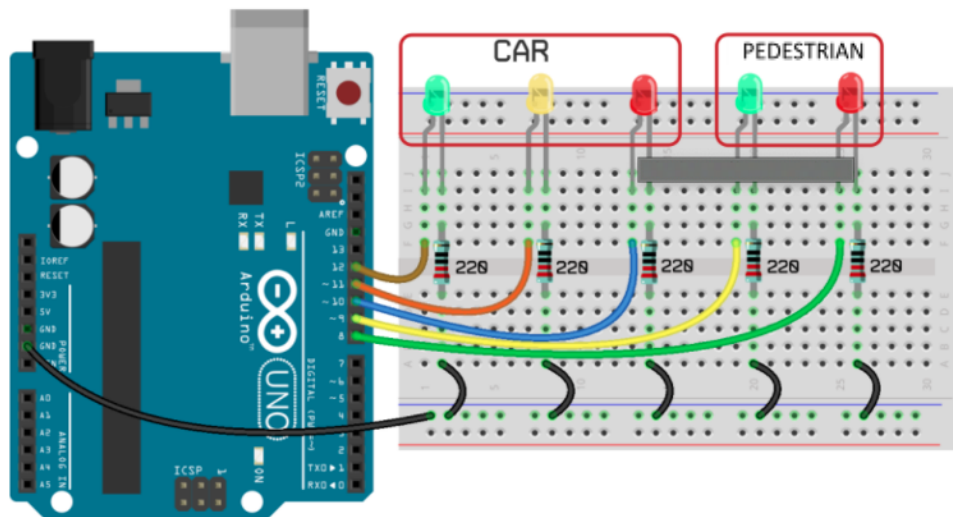

As you can see, to design or investigate a smart traffic light for cities using data from other sensors.

### STEAM Learning Outcomes

#### Science

- Use sensors (Ultrasonic and infrared) to manage the cadence of traffic lights.
- Determine the pollution generated by this traffic.

#### Technology

- Use an infrared sensor
- Use an ultrasonic sensor
- Create flowcharts in the Execute sandbox an algorithm

#### Engineering

- Design for traffic lights.

#### Art

- Gain awareness about the pollution that is generated in a city by vehicles.
- Gain environmental awareness.

#### Math

- Use ratios and proportions

### Activity Process

Teachers are recommended to take the following steps:

- Encourage students to carefully read the task statement and brainstorm street conditions in their neighborhood.

Ask students:

- What are traffic lights for?
- What are the factors that can influence the management of smart traffic lights?
- Instruct students to configure a smart traffic light using multiple locations on the map.

- Ask students to use and determine the least or most dangerous areas for pedestrians to cross a street on the map.

### **Assessment**

The following question can be considered for formative assessment purposes.

- From previous experience, it was verified that smart traffic lights could help in the traffic management of a city?
- What is the percentage reduction in accidents that the roads had with smart traffic lights?

The following is expected from students:

- Develop an intelligent traffic light that can manage the streets of a city from various points on the map in the simulation environment.
- Write and share a report on the problems current traffic lights may have on the map using appropriate technical terminology.

### **Prerequisite Skills**

Investigate the conditions which would be the ideal traffic for a city to be environmentally sustainable.

### **Career Connections**

Municipal and Regional Planning, Electrical and Electronic Engineering, Earth and Space Sciences, Environmental Engineering

### **Materials**

The simulation environment includes a street map and traffic lights.

### **Related Readings**

[1] Kanungo, A. Sharma and C. Singla, "Smart traffic lights switching and traffic density calculation using video processing," 2014 Recent Advances in Engineering and Computational Sciences (RAECS), 2014, pp. 1-6, doi: 10.1109/RAECS.2014.6799542.

[2] K. M. Almuraykhi and M. Akhlaq, "STLS: Smart Traffic Lights System for Emergency Response Vehicles," 2019 International Conference on Computer and Information Sciences (ICCIS), 2019, pp. 1-6, doi: 10.1109/ICCISci.2019.8716429.

[3] <https://core.ac.uk/download/pdf/295537708.pdf>